

**\*\*DO NOT EXCEED RECOMMENDED VEHICLE TOWING WEIGHT!\*\***

**60642**

**GM HD GOOSENECK KIT**

7/21/2020

PAGE 1 OF 5

**WARNING!!** BRAKE, FUEL, AND ELECTRICAL LINES MAY NEED TO BE LOOSENED OR REPOSITIONED TO PROVIDE CLEARANCE FOR NEW HARDWARE. ALL MODELS REQUIRE MODIFICATION OR REMOVAL OF HEAT SHIELDS. ON SHORT BED MODELS, CHECK FOR ADEQUATE TURNING CLEARANCE BETWEEN THE FRONT OF ALL TRAILERS AND THE TRUCK CAB.



Hardware List			
ITEM	QTY	PART NUMBER	DESCRIPTION
1	2	CM-SP9	.375 x 1.25 x 2.50" SQUARE HOLE SPACER
2	6	10-10292	BOLT, CAR,5/8-11 UNC,1-3/4,GRD8,YZ
3	7	10-10330	BOLT, CAR,5/8-11 UNC,1-1/2,GRD8
4	13	20-00105	NUT, SER-FLANGE,5/8-11 UNC,GRD8,YZ
5	6	30-00132	WASHER, LOCK,5/8
6	6	10-10296	HHCS,5/8-11 UNC,1-3/4,GRD8
7	14	30-00131	WASHER, FLAT,5/8
8	5	20-00062	NUT,SER-FLANGE,1/2-13 UNC,GRD8,YZ
9	4	10-10297	BOLT, CAR,1/2-13 UNC,4-1/2,GRD8,YZ
10	2	60686-UB	5/8" SQUARE U-BOLT
11	4	CM-C113-UBS	U-BOLT SPRING
12	4	20-00135	NUT, CTR LOCK,5/8-18 UNF,GRDA,CZ
13	1	10-10332	BOLT, CAR,1/2-13 UNC,5,GRD8
14	1	CM-UE1	.300" U-SHAPED EDGING
15	2	5_8 FISHWIRE	5/8" FISHWIRE
16	2	60686-SP	SPACER
17	4	60686-TS1	TUBE SPACER 1
18	1	60686-TS2	TUBE SPACER 2

Parts List			
ITEM	QTY	PART NUMBER	DESCRIPTION
A	1	60697-PS	PASSENGER SIDE PLATE
B	1	60697-DS	DRIVER SIDE PLATE
C	1	60697-DSWA	DRIVER SIDE WELDMENT
D	1	60697-PSWA	PASSENGER SIDE WELDMENT
E	1	60686-PS2	PASSENGER SIDE PLATE 2
F	1	60686-MS	MOUNTING STRAP
G	1	60686-CWA	CENTER SECTION WELDMENT
H	1	60627	2-5/16" OE GOOSENECK BALL
I	1	66155	RUBBER COVER
J	1	60614-CL	CENTER LOCATOR / TRIM SHIELD
K	1	60686-L	LATCH PLATE
L	1	60686-DB	7/8" TORQUE ADAPTER

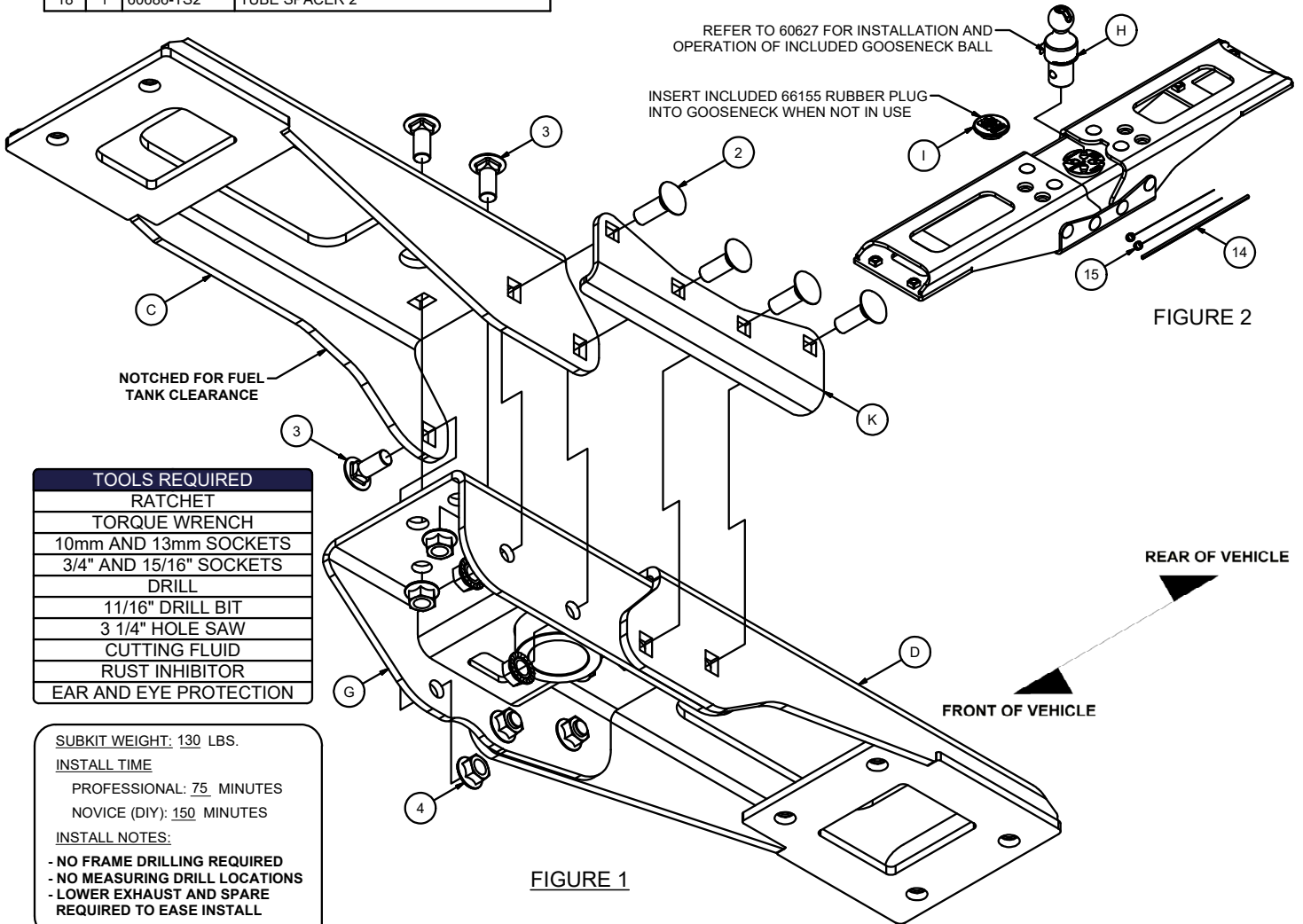

TOOLS REQUIRED
RATCHET
TORQUE WRENCH
10mm AND 13mm SOCKETS
3/4" AND 15/16" SOCKETS
DRILL
11/16" DRILL BIT
3 1/4" HOLE SAW
CUTTING FLUID
RUST INHIBITOR
EAR AND EYE PROTECTION

SUBKIT WEIGHT: 130 LBS.  
 INSTALL TIME  
 PROFESSIONAL: 75 MINUTES  
 NOVICE (DIY): 150 MINUTES  
 INSTALL NOTES:  
 - NO FRAME DRILLING REQUIRED  
 - NO MEASURING DRILL LOCATIONS  
 - LOWER EXHAUST AND SPARE REQUIRED TO EASE INSTALL

**PERIODICALLY CHECK THIS RECEIVER HITCH TO ENSURE THAT ALL FASTENERS ARE TIGHT AND THAT ALL STRUCTURAL COMPONENTS ARE SOUND.**



Scan for more information

CURT Manufacturing LLC., warrants this product to be free of defects in material and/or workmanship at the time of retail purchase by the original purchaser. If the product is found to be defective, CURT Manufacturing LLC., may repair or replace the product, at their option, when the product is returned, prepaid, with proof of purchase. Alteration to, misuse of, or improper installation of this product voids the warranty. CURT Manufacturing LLC.'s liability is limited to repair or replacement of products found to be defective, and specifically excludes liability for incidental or consequential loss or damage.

This product complies with safety specifications and requirements for connecting devices and towing systems of the state of New York, V.E.S.C.Regulation V-5 and SAE J684.

**\*\*DO NOT EXCEED RECOMMENDED VEHICLE TOWING WEIGHT!\*\***

**60642**

# GM HD GOOSENECK KIT

PAGE 2 OF 5

**WARNING!!** BRAKE, FUEL, AND ELECTRICAL LINES MAY NEED TO BE LOOSENED OR REPOSITIONED TO PROVIDE CLEARANCE FOR NEW HARDWARE. ALL MODELS REQUIRE MODIFICATION OR REMOVAL OF HEAT SHIELDS. ON SHORT BED MODELS, CHECK FOR ADEQUATE TURNING CLEARANCE BETWEEN THE FRONT OF ALL TRAILERS AND THE TRUCK CAB.

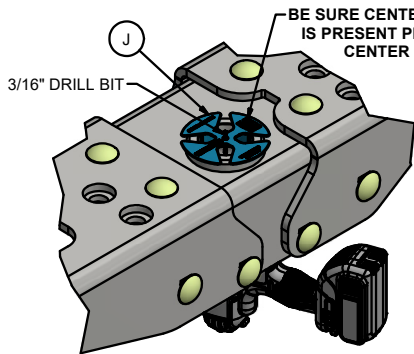

BE SURE CENTER LOCATOR / TRIM SHIELD IS PRESENT PRIOR TO INSTALLING THE CENTER SECTION ON TRUCK

3/16" DRILL BIT

**PILOT HOLE DRILL GUIDE**

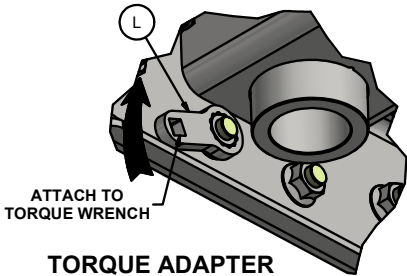

ATTACH TO TORQUE WRENCH

**TORQUE ADAPTER OPERATION**

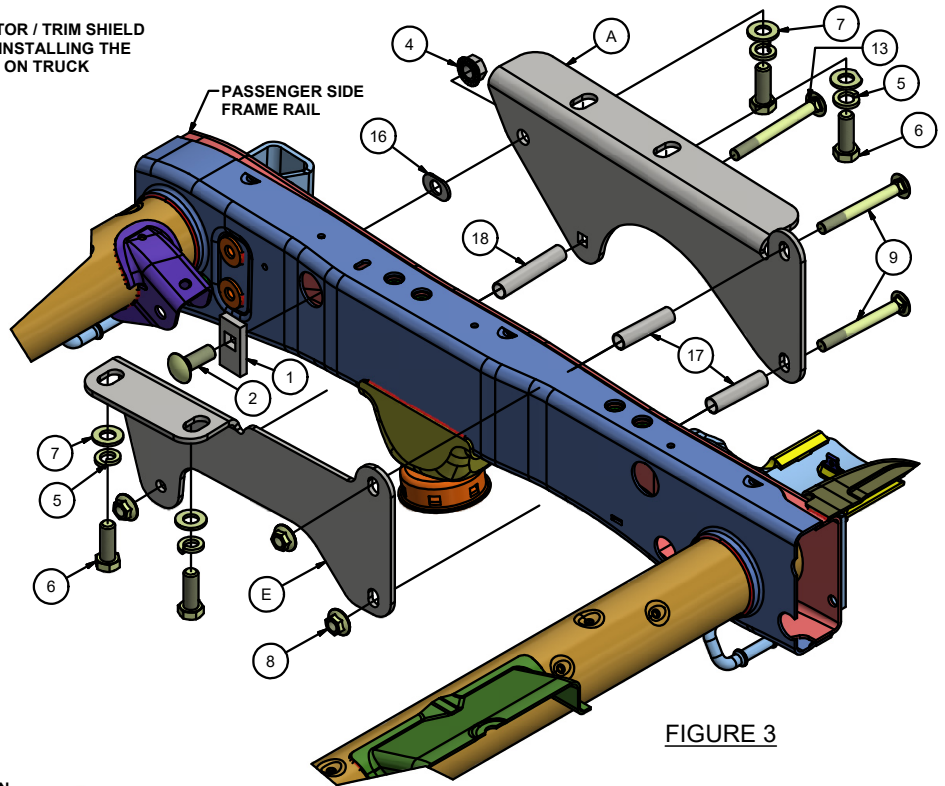

PASSENGER SIDE FRAME RAIL

**FIGURE 3**

(2) SCREWS LOCATED ON THIS BRACKET IN STEP 2

**FIGURE 4**

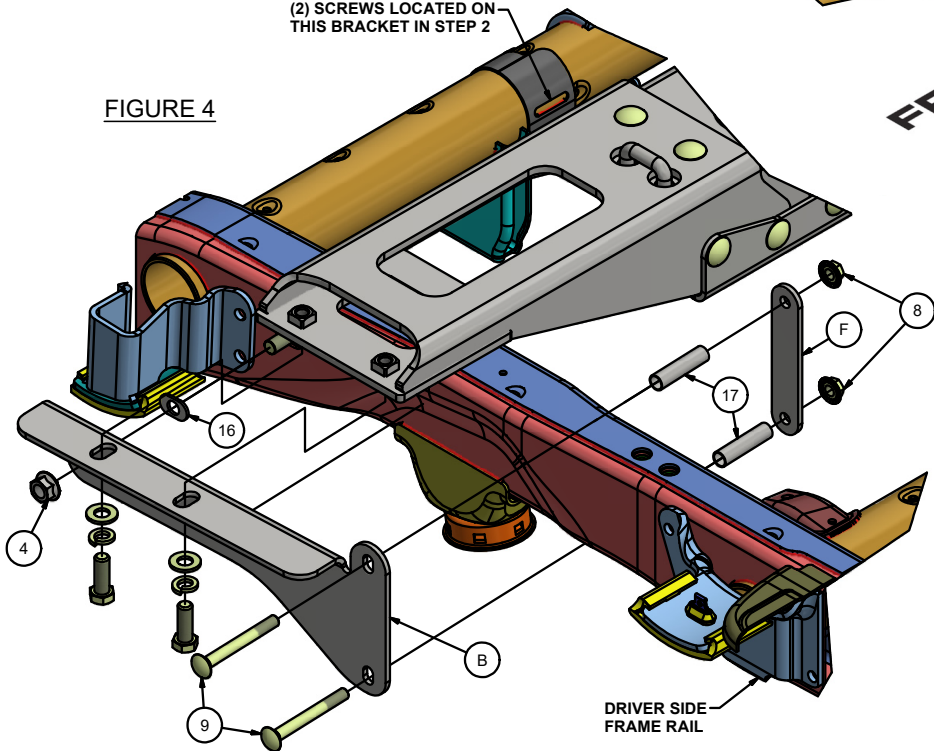

DRIVER SIDE FRAME RAIL

FRONT  
↕  
REAR

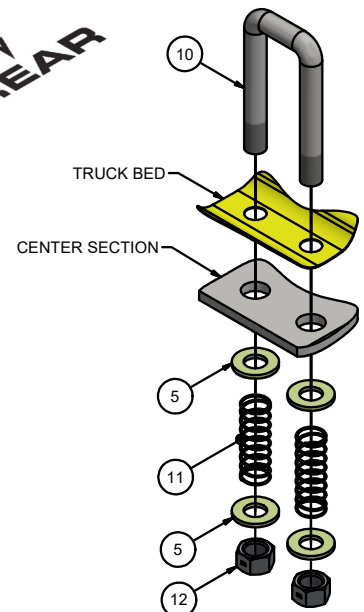

TRUCK BED

CENTER SECTION

**FIGURE 5**

**PERIODICALLY CHECK THIS GOOSENECK HITCH TO ENSURE THAT ALL FASTENERS ARE TIGHT AND THAT ALL STRUCTURAL COMPONENTS ARE SOUND.**

CURT Manufacturing LLC., warrants this product to be free of defects in material and/or workmanship at the time of retail purchase by the original purchaser. If the product is found to be defective, CURT Manufacturing LLC., may repair or replace the product, at their option, when the product is returned, prepaid, with proof of purchase. Alteration to, misuse of, or improper installation of this product voids the warranty. CURT Manufacturing LLC.'s liability is limited to repair or replacement of products found to be defective, and specifically excludes liability for incidental or consequential loss or damage.

This product complies with safety specifications and requirements for connecting devices and towing systems of the state of New York, V.E.S.C.Regulation V-5 and SAE J684.

**60642**

**GM HD GOOSENECK KIT**

**PAGE 3 OF 5**

**WARNING!!**



**BRAKE, FUEL, AND ELECTRICAL LINES MAY NEED TO BE LOOSENED OR REPOSITIONED TO PROVIDE CLEARANCE FOR NEW HARDWARE. ALL MODELS REQUIRE MODIFICATION OR REMOVAL OF HEAT SHIELDS. ON SHORT BED MODELS, CHECK FOR ADEQUATE TURNING CLEARANCE BETWEEN THE FRONT OF ALL TRAILERS AND THE TRUCK CAB.**

## **INSTALLATION STEPS**

1. Removing the spare tire may aid in installation but is not required. Lowering the exhaust on some models may be required to allow room for the center section and attachment plates.
2. Using a 10mm socket, remove the 2 screws that attach the wire harness bracket to the steel cross member to prevent damage when raising the center section into position **FIGURE 4**. Save for later re-installation.
3. Using a 13mm socket, remove the 4 screws attaching the heat shield above the rear axle and return to vehicle owner.
4. Place (2) 5/8" x 1 1/2" carriage bolts into the top mounting holes of both center attachment plates (items C and D in the parts list). Referring to **FIGURE 1**, place the center attachment plates into position starting with the driver side (C) weldment. Next raise the Passenger side Weldment (D) into position adjacent from the driver side weldment.

**NOTE: The center locator / trim shield (item J) MUST be in the top of the center section cylinder prior to center section installation.**

5. Raise the Center Section (G) into position over the rear differential. Slide the center section into the center attachment plates to allow the vertical 5/8" carriage bolts to align properly with the center section holes. Once aligned, slide both the plate and center section together and loosely install the (4) 5/8" hex flange nuts. Place the Latch Plate against the rear of the center attachment plates as shown in **FIGURE 1** and loosely install the (4) 5/8" x 1 3/4" carriage bolts into the rearward side of the center and (3) 1 1/2" bolts into the forward holes. Loosely install the (7) 5/8" hex flange nuts.
6. From under the truck loosely install the frame attachment plates (items A, B, E, and F in the parts list) to the frame as shown in **FIGURE 3** and **FIGURE 4**.
7. Loosely install the (6) 5/8" Hex bolts, lock washers and flat washers attaching the frame attachment plates to the center attachment plates.
8. Tighten the fasteners in the following order: (4) 5/8" vertical center section fasteners, (7) 5/8" horizontal center section fasteners, (6) 5/8" hex bolts, (2) 5/8" frame attachment plate fasteners, remaining 1/2" fasteners.
9. Torque all 1/2" fasteners to 110 lbs.-ft. and all 5/8" fasteners to 150 lbs.-ft. Use the supplied 7/8" torque adaptor for hard to reach 5/8" fasteners (see TORQUE ADAPTER DIAGRAM on page 2).
10. Check the area above the bed for any obstructions before drilling the 3/16" guide hole for the ball. Drill a pilot hole from underneath the truck bed through the hole in the center locator / trim shield (J) using a 3/16" drill bit. Move to above the truck, drill a 3 1/4" hole through the bed of the truck using a hole saw with the 3/16" pilot hole as a guide. Install the CM-UE1 rubber edge trim around the edge of the cut hole and trim to length.
11. Using the center section as a template, drill 4 holes through the truck bed for the safety chains using an 3/16" drill bit. Note drilling a small pilot hole prior to the 11/16" hole will ease this process. Center punching the bed from below and drilling from above may be preferred.
13. Install the safety chain U-bolt assemblies as shown in **FIGURE 5**, ensure they sit flat when in the lower position and slide easily without binding. Enlarge holes as needed for proper operation. Deburr holes and spray exposed metal with rust inhibitor. The nuts should be tightened until flush with the bottom of the U-bolt.
14. Reinstall the spare tire if removed in step 1 and wire harness bracket removed in step 2.

**PERIODICALLY CHECK THIS GOOSENECK HITCH TO ENSURE THAT ALL FASTENERS ARE TIGHT AND THAT ALL STRUCTURAL COMPONENTS ARE SOUND.**

CURT Manufacturing LLC., warrants this product to be free of defects in material and/or workmanship at the time of retail purchase by the original purchaser. If the product is found to be defective, CURT Manufacturing LLC., may repair or replace the product, at their option, when the product is returned, prepaid, with proof of purchase. Alteration to, misuse of, or improper installation of this product voids the warranty. CURT Manufacturing LLC.'s liability is limited to repair or replacement of products found to be defective, and specifically excludes liability for incidental or consequential loss or damage.

This product complies with safety specifications and requirements for connecting devices and towing systems of the state of New York, V.E.S.C.Regulation V-5 and SAE J684.

# CAB TO TRAILER CLEARANCE

**\*\*\*DO NOT EXCEED VEHICLE MANUFACTURER'S RECOMMENDED TOWING CAPACITY.\*\*\***

HAVING INSTALLATION QUESTIONS? CALL TECHNICAL SUPPORT AT 1-877-287-8634

**\*\*REMOVAL OF REAR WINDOW ACCESSORIES MAY BE REQUIRED\*\***

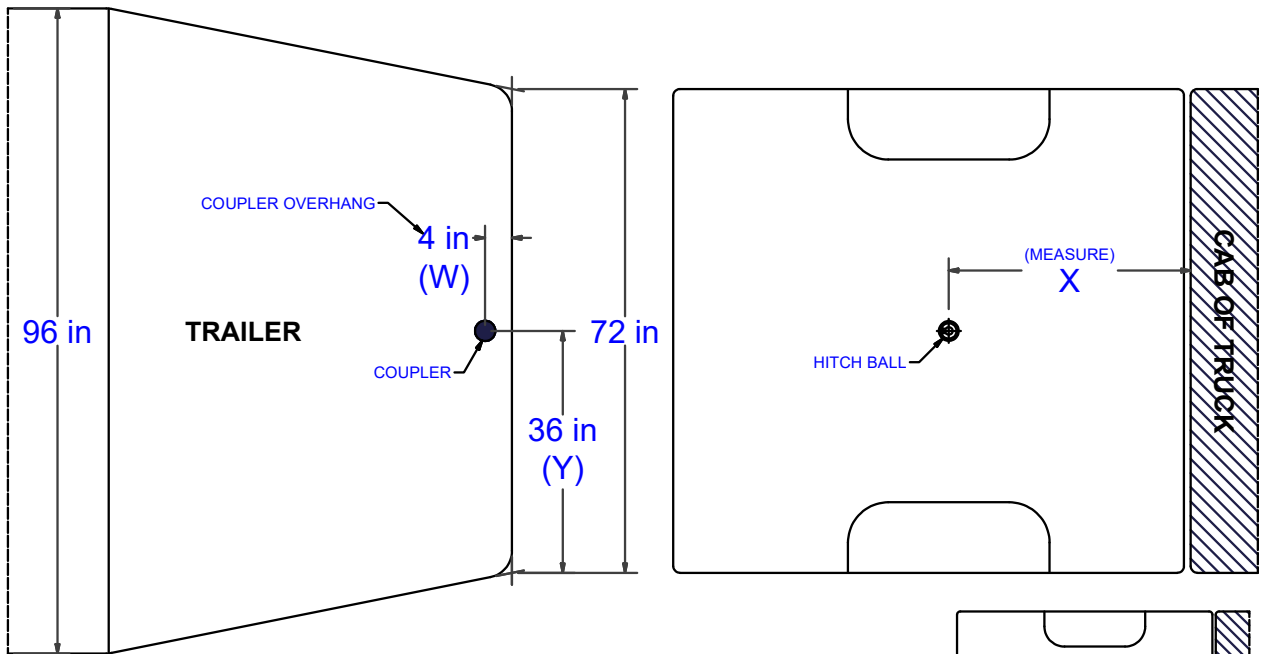

**\*\*GENERALLY, TAPERED NOSE TRAILERS ADHERE TO THE FOLLOWING DESIGNS:\*\***  
 8 FT. WIDE TRAILERS TAPER TO 6 FT. AT THE COUPLER  
 7 FT. WIDE TRAILERS TAPER TO 5 FT. AT THE COUPLER

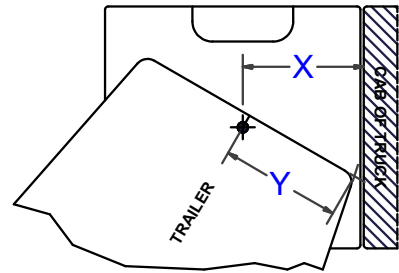

## CLEARANCE CALCULATION

$$\begin{matrix} \text{(CAB TO BALL CENTER)} & - & 1/2 \text{ (TRAILER WIDTH)} & = & \text{(MINIMUM CLEARANCE)} \\ \text{(X)} & - & \text{(Y)} & = & \text{(Z)} \end{matrix}$$

IF THERE IS AN OVERHANG FROM THE COUPLER THEN THE EQUATION IS:

$$\text{[(X) - (W)]} - \text{(Y)} = \text{(Z)}$$

**\*\*\*IF (Z) IS POSITIVE, TRAILER WILL NOT INTERFERE WITH CAB OF TRUCK.\*\*\***  
**IF (Z) IS NEGATIVE, TRAILER WILL INTERFERE WITH CAB OF TRUCK!!!**

### EXAMPLE:

#### STANDARD TRAILER

$$\begin{aligned} X - Y &= Z \\ 35 - 36 &= -1 \\ \text{(TRAILER WILL INTERFERE WITH CAB)} \end{aligned}$$

#### TRAILER WITH OVERHANG

$$\begin{aligned} \text{[(X) - (W)]} - Y &= Z \\ [35 - 4] - 36 &= -5 \\ \text{(TRAILER WILL INTERFERE WITH CAB)} \end{aligned}$$

### YOUR CALCULATION:

(CAB TO BALL CENTER) \_\_\_\_\_

(COUPLER OVERHANG) \_\_\_\_\_

1/2 (TRAILER WIDTH) \_\_\_\_\_

(MINIMUM CLEARANCE) \_\_\_\_\_

**PERIODICALLY CHECK THIS RECEIVER HITCH TO ENSURE THAT ALL FASTENERS ARE TIGHT AND THAT ALL STRUCTURAL COMPONENTS ARE SOUND.**

CURT Manufacturing LLC., warrants this product to be free of defects in material and/or workmanship at the time of retail purchase by the original purchaser. If the product is found to be defective CURT Manufacturing LLC., may repair or replace the product, at their option, when the product is returned, prepaid, with proof of purchase. Alteration to, misuse of, or improper installation of this product voids the warranty. CURT Manufacturing LLC.'s liability is limited to repair or replacement of products found to be defective, and specifically excludes liability for incidental or consequential loss or damage.

# IMPORTANT TOWING INFORMATION

PAGE 5 OF 5

**\*\*\*DO NOT EXCEED VEHICLE MANUFACTURER'S RECOMMENDED TOWING CAPACITY.\*\*\***

HAVING INSTALLATION QUESTIONS? CALL TECHNICAL SUPPORT AT 1-877-287-8634

## **BEFORE TOWING THE FIRST TIME:**

- Verify adequate turning clearance between the truck cab / box corners and trailer(s).
- Check truck box clearance. There should be a minimum clearance of 6" between the bottom of the trailer(s) overhang and the top of the box sides.
- Verify all hardware is torqued to the proper specification.
- Verify the trailer safety chain length. Too much slack in the chain may prevent maintaining control in the event of separation. Leave only enough slack to allow full turning without interference.
- Verify the trailer attachments to the safety chain loops are secure (cannot be shaken free during towing).

## **MAINTENANCE:**

- Keep gooseneck ball, receiver, and trailer coupler lubricated regularly. Use silicone spray or equivalent to prevent wear / rust.
- Keep gooseneck ball, receiver, and trailer coupler free of dirt and other foreign debris.  
**Note:** Failure to maintain your towing system could result in poor performance and/or catastrophic failure.

## **BEFORE TOWING EVERY TIME:**

- Ensure all fasteners are tight and that all structural components are sound.  
**Note:** Do not tow trailer with worn or damaged parts.
- Attach trailer securely to safety chain loops.
- Ensure the trailer weight does not exceed any part of your towing system. Be sure load is heavier towards front of the trailer while not exceeding the hitch tongue weight. Be sure trailer load is secured to prevent shifting and centered from left to right. **Note:** Never load the trailer heavier behind the trailer axle(s).
- Check tires to ensure they are inflated to the proper specification. Follow vehicle and trailer recommendations.
- Verify trailer lights, electric brakes, and breakaway switches are working properly.

## **WARNING!!**

- Vehicle performance (braking, handling, acceleration, turning radius) can be drastically affected by the trailer. Allow additional time / space for stopping, changing lanes, passing and turning.
- Do not tow more than one trailer at a time. This may cause loss of control.
- Severe bumps can damage your towing system. Avoid or drive slowly over rough terrain.

**PERIODICALLY CHECK THIS RECEIVER HITCH TO ENSURE THAT ALL FASTENERS ARE TIGHT AND THAT ALL STRUCTURAL COMPONENTS ARE SOUND.**

CURT Manufacturing LLC., warrants this product to be free of defects in material and/or workmanship at the time of retail purchase by the original purchaser. If the product is found to be defective CURT Manufacturing LLC., may repair or replace the product, at their option, when the product is returned, prepaid, with proof of purchase. Alteration to, misuse of, or improper installation of this product voids the warranty. CURT Manufacturing LLC.'s liability is limited to repair or replacement of products found to be defective, and specifically excludes liability for incidental or consequential loss or damage.