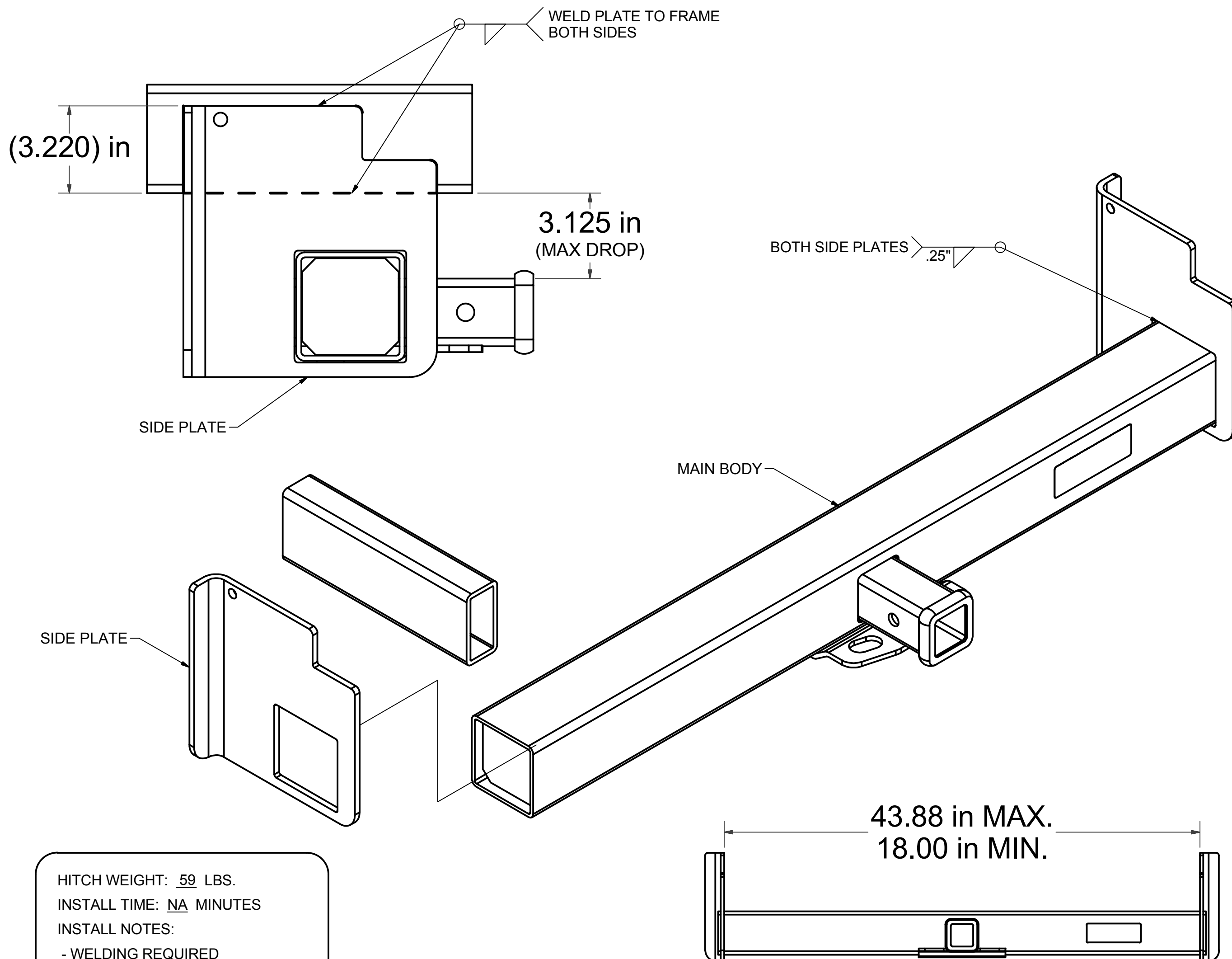

15901**UNIVERSAL WELD-ON RECEIVER HITCH**

9/14/2015

GROSS LOAD CAPACITY WHEN USED AS A WEIGHT CARRYING HITCH: 15,000 LBS. TRAILER WEIGHT & 1,500 LBS. TONGUE WEIGHT.

*****DO NOT EXCEED VEHICLE MANUFACTURER'S RECOMMENDED TOWING CAPACITY.*****

HITCH WEIGHT: 59 LBS.
 INSTALL TIME: NA MINUTES
 INSTALL NOTES:
 - WELDING REQUIRED
 (CLEAN ALL SURFACES)
 - 2-3 PEOPLE RECOMMENDED

INSTALLATION STEPS

1. Locate where the hitch side plates will be mounted to the frame of the vehicle. Clean surface of frame in weld locations down to bare metal. Clean off powder coating on side plates where they will be mounted to the frame and to the main body of the hitch. Clean powder coating off of main body where side plates will be welded.

***** Warning: ***** If metal surfaces are not completely bare, weld will not be the required strength and may void warranty.

2. Slide side plates onto the main body and raise into position to be welded. Secure/clamp side plates to frame in position and center main body between side plates.

3. Weld side plates to frame of vehicle and main body, to AWS welding standards. Trim off any excess main body beyond the side plates as desired.

PERIODICALLY CHECK THIS RECEIVER HITCH TO ENSURE THAT ALL FASTENERS ARE TIGHT AND THAT ALL STRUCTURAL COMPONENTS ARE SOUND.

Curt Manufacturing Inc., warrants this product to be free of defects in material and/or workmanship at the time of retail purchase by the original purchaser. If the product is found to be defective, Curt Manufacturing Inc., may repair or replace the product, at their option, when the product is returned, prepaid, with proof of purchase. Alteration to, misuse of, or improper installation of this product voids the warranty. Curt Manufacturing Inc.'s liability is limited to repair or replacement of products found to be defective, and specifically excludes liability for incidental or consequential loss or damage.