

INSTALLATION MANUAL

13484

Level of Difficulty

Moderate

Installation difficulty levels are based on time and effort involved and may vary depending on the installer level of expertise, condition of the vehicle and proper tools and equipment.

Weight Carrying Capacity

Gross trailer weight (GTW)	4,000 lbs.
Tongue weight (TW)	400 lbs.

Parts List

Item	Qty	Description
1	2	Hex bolt, M10-1.5 x 45mm, CL10.9
2	2	Conical-toothed washer, 7/16"

Tools Required

Ratchet	Torque wrench
Socket, 15mm	Tape measure
Socket extension, 6"	Paint marker
Torx bit, T-20	Pry tool
Utility knife	--

* For a tools reference guide visit curtmfg.com/trailer-hitch-installation

⚠ WARNING

Never exceed the vehicle manufacturer's recommended towing capacity.

Product Photo



NOTICE

Visit www.curtmfg.com for a full-color copy of this instruction manual, as well as helpful videos, guides and much more!

Before you begin installation, read all instructions thoroughly.

Proper tools will improve the quality of installation and reduce the time required.

This installation requires:

- Use of existing hardware
- Part removal (rear bumper fascia and bumper beam)
- Trimming of the rear bumper fascia
- Trimming of caulk around the bumper beam, if applicable

Periodic inspection of the trailer hitch should be performed to ensure all mounting hardware remains tight and structural components are secure.

To help prevent damage to the product or vehicle, refer to the specified torque specifications when securing hardware during the installation process.

SAFETY INSTRUCTIONS

Safety glasses should be worn at all times while installing this product.

Product Registration and Warranty

CURT stands behind our products with industry-leading warranties. To get copies of the product warranties, register your purchase or provide feedback, visit: warranty.curtgroup.com/surveys

ASSEMBLY

Parts List

Item	Qty	Description
1	2	Hex bolt, M10-1.5 x 45mm, CL10.9
2	2	Conical-toothed washer, 7/16"

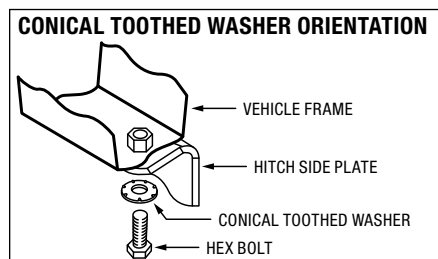
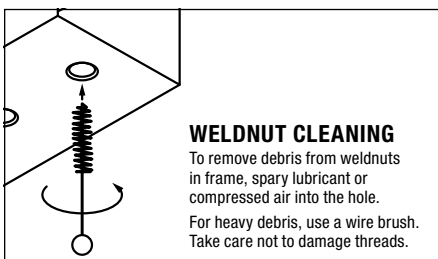
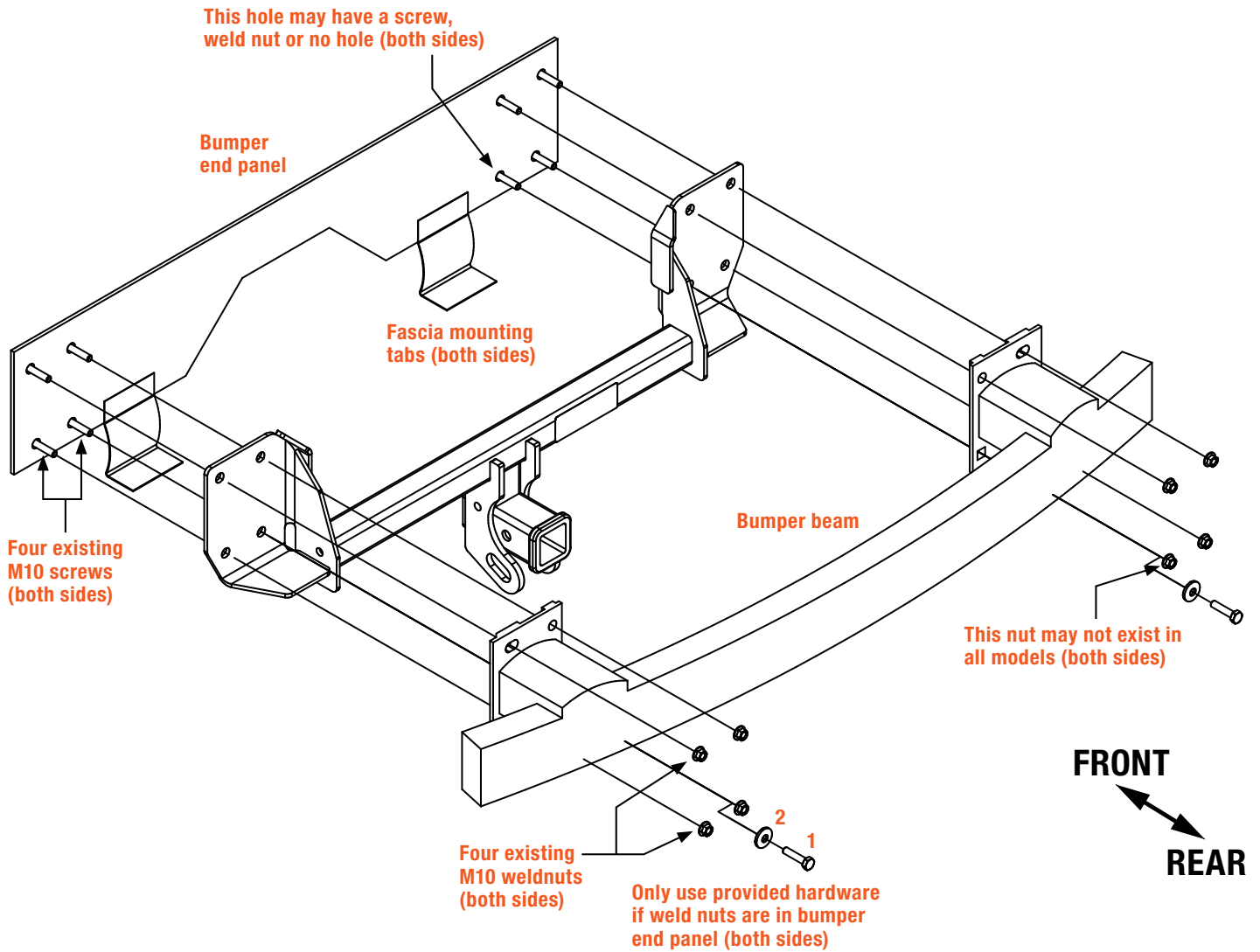

Step 1

Remove four screws from the bottom of the fascia.

Remove seven screws from the wheel well on both sides of the vehicle.

Set hardware aside for reinstallation in Step 8.



Step 2

Open the trunk and remove two bump stops, one on each side of the vehicle.

Set aside for reinstallation in Step 7.

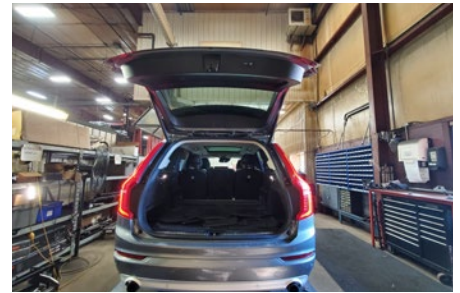

Step 3

Gently pull enough of the wheel well trim out to remove the rear fascia on both sides of the vehicle. Gently remove the rear bumper fascia by pressing the three clips on the rear bumper fascia on each side, gently pulling the rear bumper fascia off the vehicle, and unplugging one or two connectors from fascia.

Note: Be sure to unplug the connectors from the fascia before completely removing.

Set the fascia and connector(s) aside for reinstallation in Step 7.

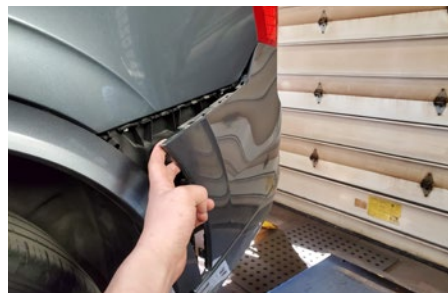
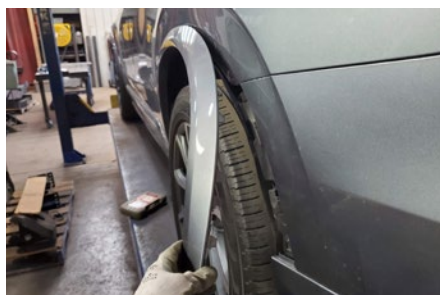

Step 4

Remove the bumper beam by unscrewing the three or four M10 flange nuts from the bumper beam on both sides of the vehicle. If applicable, trim the caulk around the bumper beam. It is recommended to apply a bead of RTV silicone (not included) around the frame opening to prevent water intrusion prior to hitch installation.

Set the bumper beam and fasteners aside for reinstallation in Step 6.

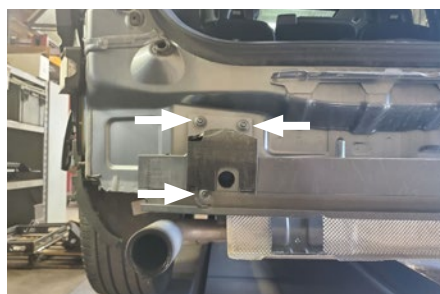

Step 5

Raise the trailer hitch into position over the existing M10 bolts on both sides of the vehicle. Place the bumper beam over the hitch.

Loosely install the three or four removed M10 flange nuts from Step 3 on both sides of the vehicle. If the bumper has three bolts and a weld nut that is accessible in the bumper end panel, screw in the provided M10 hex bolts (#1) and conical washers (#2). Torque all M10 hardware to 45 lb-ft.

Note: For easier nut installation, start with the lower nuts on the passenger side. Push on the bumper beam and screw the nut on just enough for thread engagement. Repeat on the lower nuts on the driver side. Loosely install the upper nuts on the passenger and driver side. Torque the upper nuts and then the lower nuts on the passenger side. Repeat on the driver side.



Step 6

Trim the fascia by cutting a centered rectangle 2-1/2" from the frontmost edge at the bottom of the fascia and 3-1/2" wide.

Reinstall the bumper stops, electrical connector(s) and fascia removed in Steps 2 and 3.

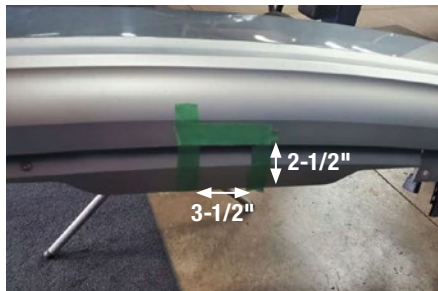

Step 7

Reinstall all fasteners removed in Step 1.



Final Installed Image



TOWING BASICS & SAFETY INFORMATION

For information on safely towing your trailer, visit curtmfg.com/understanding-towing.