

13077**BMW X5 AND X6**

7/9/2020

GROSS LOAD CAPACITY WHEN USED AS A WEIGHT CARRYING HITCH: 6,000 LBS. TRAILER WEIGHT & 600 LBS. TONGUE WEIGHT.
 GROSS LOAD CAPACITY WHEN USED AS A WEIGHT DISTRIBUTION HITCH: 6,000 LBS. TRAILER WEIGHT & 600 LBS. TONGUE WEIGHT.

DO NOT EXCEED VEHICLE MANUFACTURER'S RECOMMENDED TOWING CAPACITY.

WARNING: ALL NON-TRAILER LOADS APPLIED TO THIS PRODUCT MUST BE SUPPORTED BY AUXILIARY STABILIZING STRAPS.

** FAILURE TO PROPERLY SUPPORT NON-TRAILER LOADS WILL VOID PRODUCT WARRANTY**

HAVING INSTALLATION QUESTIONS? CALL TECHNICAL SUPPORT AT 1-877-287-8634

		Parts List	
ITEM	QTY	PART NUMBER	DESCRIPTION
1	8	20-00133	NUT,HEX,M12x1.5,CL10.9,YZ
2	8	30-00149	WASHER,S-CON,1/2,YZ
3	4	10-10501	RIVET,1/4,BLACK

TOOLS REQUIRED
PLASTIC RIVET GUN
8mm & 18mm SOCKETS
RATCHET
PRY TOOL
TORQUE WRENCH
TAPE MEASURE
AVIATION SHEARS
8" SOCKET EXTENSION
SAFETY GLASSES

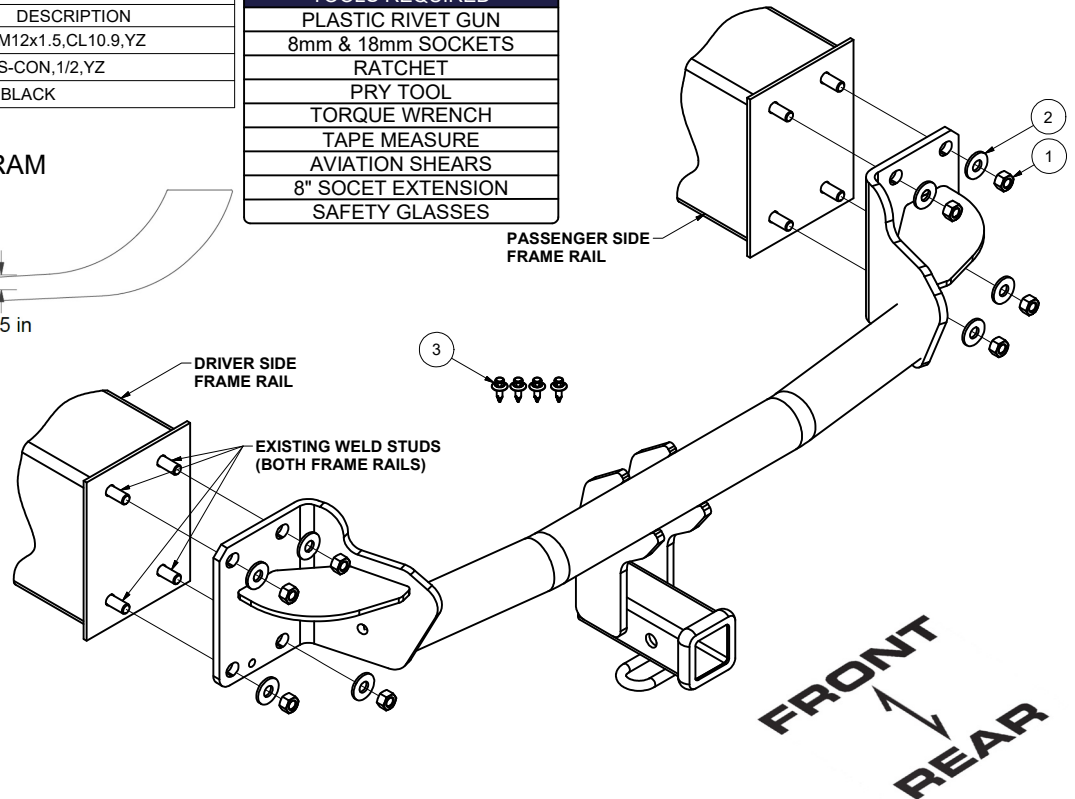
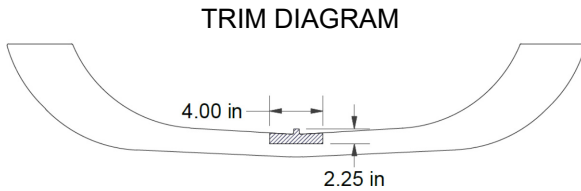

HITCH WEIGHT: 43 LBS.

INSTALL TIME

PROFESSIONAL: 90 MINUTES

NOVICE (DIY): 180 MINUTES

INSTALL NOTES:

- FASCIA TRIMMING REQUIRED
- NO DRILLING REQUIRED

INSTALLATION STEPS

1. To remove rear lower bumper fascia, remove (2) plastic rivets from wheel well opening on each side, discard rivets when removed. Gently pull back wheel well cover and remove (1) exposed fastener using 8mm socket on each side.
2. Gently unclip (1) reflector on each side of rear fascia to expose and remove (1) fastener on each side using 8mm socket.
3. Remove (6) fasteners located on bottom of rear fascia, if present unplug electrical harness.
NOTE: On 2011 - PRESENT models remove tail lights by removing access panel located in trunk of vehicle and remove (2) nuts on each side using 8mm socket, unplug electrical harness. Set aside for reinstallation.
4. Gently remove bumper fascia by releasing press in tabs along top portion of bumper fascia. To remove bumper beam remove (4) nuts on each side using 18mm socket. Once removed return bumper beam to owner.
NOTE: Lowering tailgate to 45 degree angle allows access to upper mounting nuts.
5. Raise hitch into position aligned with vehicle studs and secure using supplied M12 hardware.
6. Torque all 12mm hardware to 82 lb-ft.
7. If required, trim bumper fascia as shown in trim diagram using aviation shears.
NOTE: All dimensions are approximate, confirm fit prior to trim.
8. Reinstall bumper fascia onto vehicle using provided rivets.
NOTE: OEM tow hooks can no longer be used at rear of vehicle.

PERIODICALLY CHECK THIS RECEIVER HITCH TO ENSURE THAT ALL FASTENERS ARE TIGHT AND THAT ALL STRUCTURAL COMPONENTS ARE SOUND.

Curt Manufacturing Inc., warrants this product to be free of defects in material and/or workmanship at the time of retail purchase by the original purchaser. If the product is found to be defective, Curt Manufacturing Inc., may repair or replace the product, at their option, when the product is returned, prepaid, with proof of purchase. Alteration to, misuse of, or improper installation of this product voids the warranty. Curt Manufacturing Inc.'s liability is limited to repair or replacement of products found to be defective, and specifically excludes liability for incidental or consequential loss or damage.

INSTALLATION WALKTHROUGH:

3. Remove (6) screws located on bottom of bumper fascia, if present unplug electrical harness.

NOTE: On 2011-PRESENT models remove tail lights by removing access panel located in trunk of vehicle and remove (2) nuts on each side using 8mm socket, unplug electrical harness. Set aside for reinstallation.

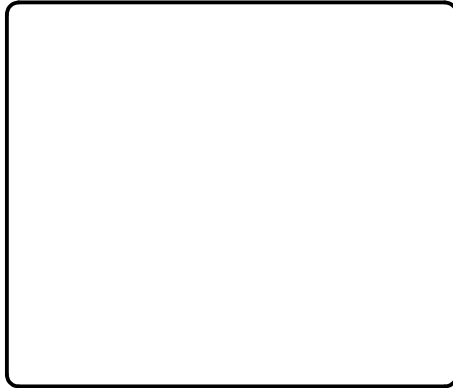

4. Gently remove bumper fascia by releasing press in tabs along top portion of bumper fascia. To remove bumper beam remove (4) nuts on each side using 18mm socket. Once removed return bumper beam to owner

NOTE: Lowering tailgate to 45 degree angle allows access to upper mounting nuts

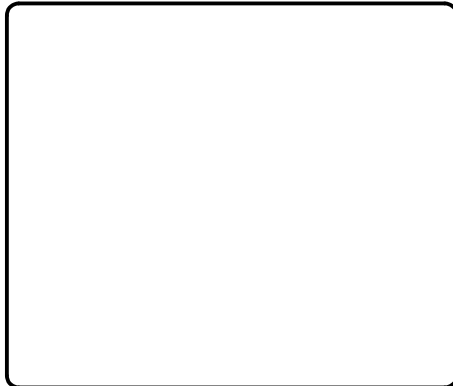
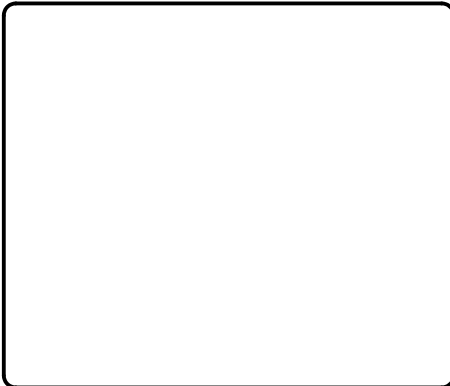

5. Raise hitch into position aligned with vehicle studs and secure using supplied M12 hardware.

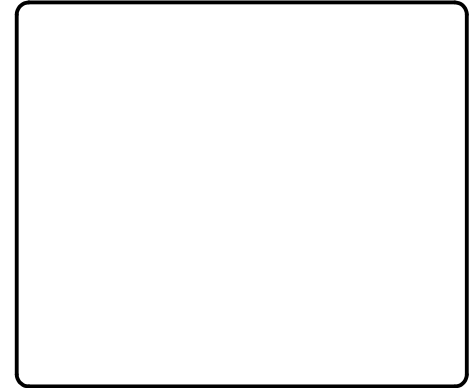
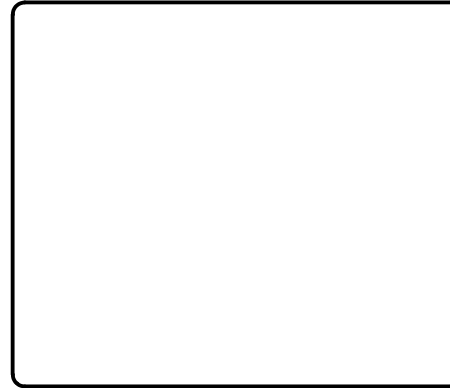

6. Torque all 12mm hardware to 82 ft-lbs

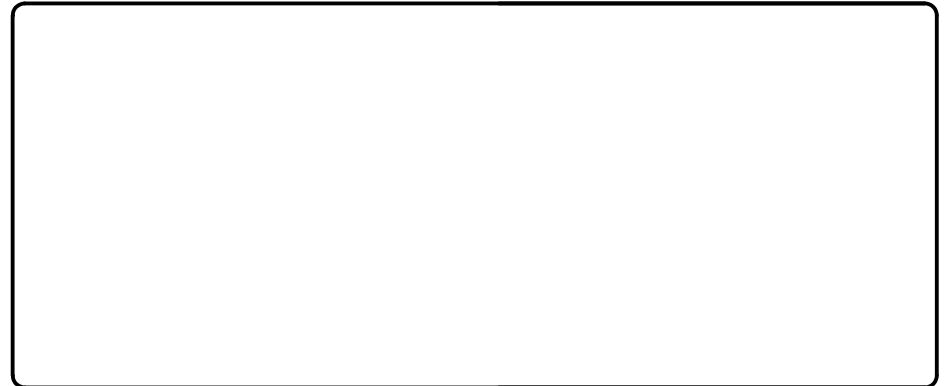

INSTALLATION WALKTHROUGH:

7. If required, trim bumper fascia as shown in trim diagram using aviation shears.

NOTE: All dimensions are approximate, confirm fit prior to trim.

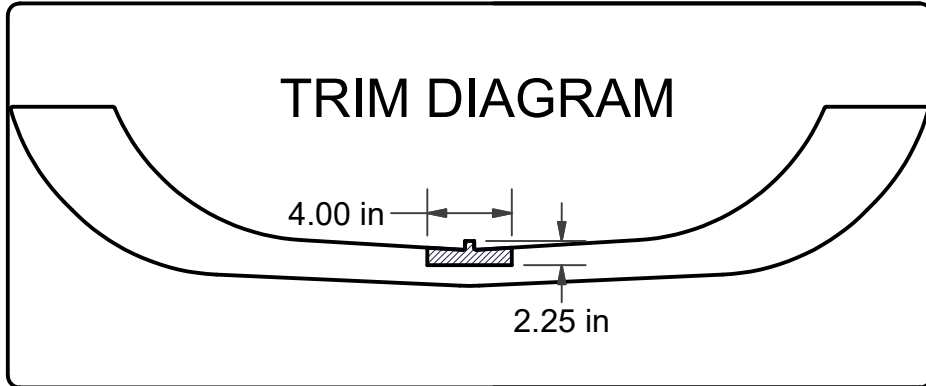

8. Reinstall bumper fascia onto vehicle using provided rivets.

NOTE: OEM tow hooks can no longer be used at rear of vehicle



TOWING SAFETY INFORMATION

Gross Trailer Weight / GTW

The Gross Trailer Weight is the weight of the trailer & cargo. Measure this by putting the fully loaded trailer on a vehicle scale.

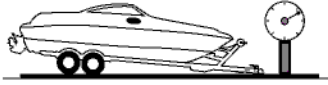

Tongue Weight / TW

The downward force that is exerted on the hitch ball by the coupler. The tongue weight will vary depending on where the load is positioned in relationship to the trailer axle(s). To measure the tongue weight, use either a commercial scale or a bathroom scale with the coupler at towing height. When using a bathroom scale with heavier tongue weights, use the method shown and multiply the scale reading by 3.

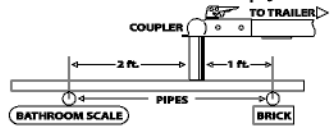

Weight Carrying / WC

The total weight of both the trailer and the cargo inside. Never exceed the weight capacity of your trailer hitch.

Weight Distribution / WD

Used to balance the weight of the cargo between the front and rear wheels throughout the trailer, allowing for better steering, braking, and level riding.



Sway Control

A device used to reduce the lateral movements of the trailer that are caused by the wind. This works in conjunction with a weight distribution hitch. Do not use this on a class 1 or 2 hitch, or with surge brakes.

How Much Can You Safely Tow?

TONGUE WEIGHT (lb)	1000	2000	3000	4000	5000	6000	7000	8000	10,000	12,000
Tongue weight should be about 10 to 15 percent of the gross trailer weight.										
CLASS 1										
CLASS 2										
CLASS 3										
CLASS 4										
CLASS 5										
TRAILER TYPE										
Camper	11'	12'	13'	14'	15'	16'				
lbs.	1100	1200	1300	1400	1500	1600				
Vacation	18'	19'	20'	22'	24'	26'	28'	30'	32'	
lbs.	2100	2400	2700	3000	3300	3600	3900	4200	4500	4800
Vacation	18'	19'	20'	22'	24'	26'	28'	30'	32'	
lbs.	2800	3200	3600	4000	4400	4800	5200	5600	6000	6400
5th Wheel										

Refer to owner's manual for towing capabilities and limitations.

Ball Mount

The ball mount is placed inside the opening of the receiver hitch which is mounted to the vehicle. Make sure a hitch pin and clip is properly securing the ball mount to the receiver hitch before you begin towing.

- A: Rise. B: Drop. C: Hole Size. D: Length.

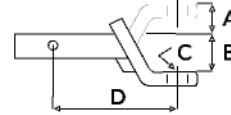

Trailer Ball

The connection from the hitch to the trailer. There are many factors that determine the correct hitch ball:

- Number one is the hitch ball's gross trailer weight rating.
- The mounting platform must be at least 3/8" thick.
- The hole diameter must not be more than 1/16" larger than the threaded shank.
- Every time you tow, check the nut and lock washer to make sure they are fastened securely.
- A: Ball Dia. B: Shank Length. C: Shank Dia. D: Shank Rise.

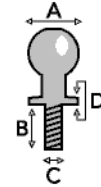

Coupler

The component that is placed over the trailer ball to connect the vehicle to the trailer. Be sure that the coupler size matches the size of the hitch ball and that the coupler handle is securely fastened. To determine what size hitch ball you need for your application you will need to know the size of coupler that is on the trailer. Be sure your coupler is properly adjusted to the ball you are using.

NOTE: For added security the use of safety devices such as Coupler Safety Pins and Locks is strongly recommended.

Safety Chains

Safety chains are a requirement and should be crossed under the tongue of the trailer so that the tongue will not drop to the road if it becomes separated from the hitch. Always leave enough slack so you can turn. Never allow the safety chains to drag on the ground and never attach the chains to the bumper.

Trailer Classification: Safety Chain Breaking Force - Minimum

Class 1: 2,000 lbs. (8.9 kN)

Class 2: 3,500 lbs. (15.6 kN)

Class 3: 5,000 lbs. (22.2 kN)

The strength rating of each length of safety chain or its equivalent and its attachments shall be equal to or exceed in minimum breaking force the GVWR (Gross Vehicle Weight Rating) of the trailer.

Electrical

Trailer lights, Electric Brakes, Break-away systems - Every time you tow, be sure to check that all components are working properly.

Wiring identification by color:

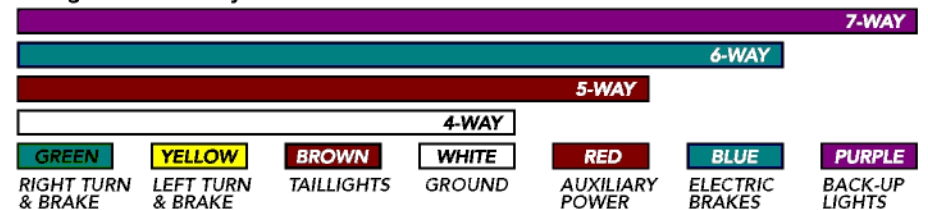

CURT DISCLAIMER: WIRING COLOR SHOWN WORK IN CONJUNCTION WITH CURT MANUFACTURING PRODUCTS.