

11730**95-98 SAAB 900 CONVERTIBLE & 94-98 HATCHBACK (INCL TURBO)**

11/26/2012

GROSS LOAD CAPACITY WHEN USED AS A WEIGHT CARRYING HITCH: 2,000 LBS. TRAILER WEIGHT & 200 LBS. TONGUE WEIGHT.

*****DO NOT EXCEED VEHICLE MANUFACTURER'S RECOMMENDED TOWING CAPACITY.*******WARNING: ALL NON-TRAILER LOADS APPLIED TO THIS PRODUCT MUST BE SUPPORTED BY AUXILIARY STABILIZING STRAPS.****** FAILURE TO PROPERLY SUPPORT NON-TRAILER LOADS WILL VOID PRODUCT WARRANTY****

HAVING INSTALLATION QUESTIONS? CALL TECHNICAL SUPPORT AT 1-877-287-8634

Parts List			
ITEM	QTY	PART NUMBER	DESCRIPTION
1	3	M10 - 1.5 x 30 HEX	HEX BOLT
2	3	7/16 LOCK WASHER	HELICAL LOCK WASHER
3	4	3/8 - 16 x 1 1/4	HEX BOLT
4	4	3/8"	FENDER WASHER
5	4	3/8"	LOCK WASHER
6	4	3/8 - 16	HEX NUT

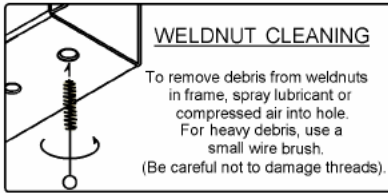
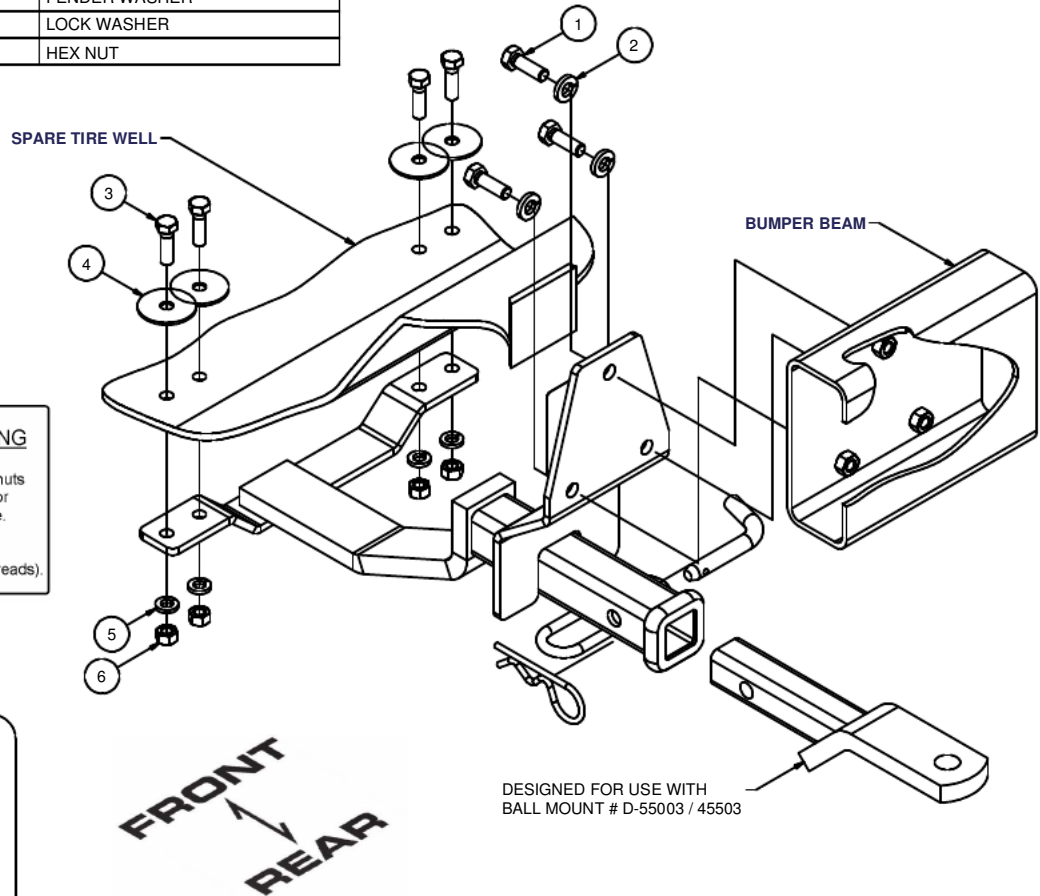

HITCH WEIGHT: 11 LBS.

INSTALL TIME

PROFESSIONAL: 60 MINUTES

NOVICE (DIY): 120 MINUTES

INSTALL NOTES:

- DRILLING REQUIRED
- REMOVE SPARE TIRE
- REMOVE BUMPER
- REMOVE FASCIA

INSTALLATION STEPS

1. Temporarily remove the rear bumper. Unbolt two tie-down brackets in the trunk at rear wall and remove two plastic "nuts" holding plastic panel in place. Remove panel. Inside rear body panel remove four nuts using 17mm wrench. Pull bumper fascia out at tire well and inside bumper rearward, use care with bumper to prevent scratches.
2. Remove any existing fasteners from holes in the center of the bumper beam. Fasten hitch to bumper using fasteners provided.
3. Remove spare tire and using hitch as a template drill tire well four places to accept 3/8" diameter screws of fasteners.
4. Torque 3/8" fasteners to 45 ft-lbs. and 10mm fasteners to 45 ft-lbs.

PERIODICALLY CHECK THIS RECEIVER HITCH TO ENSURE THAT ALL FASTENERS ARE TIGHT AND THAT ALL STRUCTURAL COMPONENTS ARE SOUND.

Curt Manufacturing Inc., warrants this product to be free of defects in material and/or workmanship at the time of retail purchase by the original purchaser. If the product is found to be defective, Curt Manufacturing Inc., may repair or replace the product, at their option, when the product is returned, prepaid, with proof of purchase. Alteration to, misuse of, or improper installation of this product voids the warranty. Curt Manufacturing Inc.'s liability is limited to repair or replacement of products found to be defective, and specifically excludes liability for incidental or consequential loss or damage.