

**11721****88-93 MERCEDES BENZ 190 SEDAN**

12/7/2012

GROSS LOAD CAPACITY WHEN USED AS A WEIGHT CARRYING HITCH: 1,500 LBS. TRAILER WEIGHT &amp; 150 LBS. TONGUE WEIGHT.

**\*\*\*DO NOT EXCEED VEHICLE MANUFACTURER'S RECOMMENDED TOWING CAPACITY.\*\*\*****WARNING: ALL NON-TRAILER LOADS APPLIED TO THIS PRODUCT MUST BE SUPPORTED BY AUXILIARY STABILIZING STRAPS.****\*\* FAILURE TO PROPERLY SUPPORT NON-TRAILER LOADS WILL VOID PRODUCT WARRANTY\*\***

HAVING INSTALLATION QUESTIONS? CALL TECHNICAL SUPPORT AT 1-877-287-8634

Parts List			
ITEM	QTY	PART NUMBER	DESCRIPTION
1	8	3/8 - 16 x 1 1/4	HEX BOLT
2	4	3/8"	FENDER WASHER
3	8	3/8"	LOCK WASHER
4	8	3/8 - 16	HEX NUT
5	1	CM-11721-MS	2.000 x .250" MOUNTING STRAP

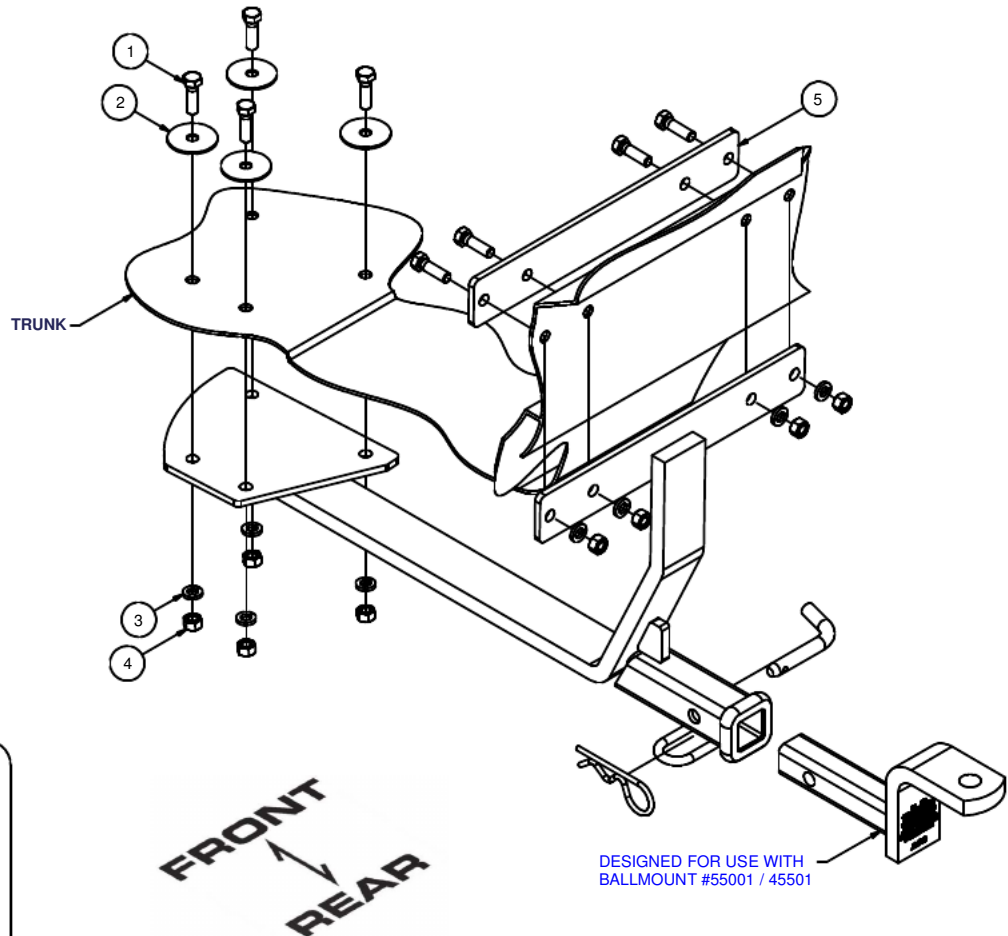

HITCH WEIGHT: 19 LBS.

INSTALL TIME

PROFESSIONAL: 20 MINUTES

NOVICE (DIY): 40 MINUTES

INSTALL NOTES:

- DRILLING REQUIRED
- BUMPER REMOVAL REQUIRED
- REMOVE PLASTIC PANELS

**INSTALLATION STEPS**

1. Remove car's rear bumper. Bumper fasteners are located inside trunk in rear corner under plastic snap covers, three per side. Remove car's spare tire. Swing trim panel in trunk compartment at rear away for clearance to "ledge" area.
2. Locate centerline across rear of car and mark so hitch can be located on center of car. Position the hitch on the car against rear panel and tire well as shown. Mark panel and tire well for mounting holes. Adjust height of hitch at rear panel so mounting hole location places reinforcement plate on body ledge as shown. Centerpunch and drill car's rear panel and tire well for 3/8" diameter mounting screws.
3. Mount hitch to car using supplied hardware. Reinforcement plate mounts inside rear panel resting on "ledge" area of body.
4. Torque all fasteners to 45 ft-lbs.

**PERIODICALLY CHECK THIS RECEIVER HITCH TO ENSURE THAT ALL FASTENERS ARE TIGHT AND THAT ALL STRUCTURAL COMPONENTS ARE SOUND.**

Curt Manufacturing Inc., warrants this product to be free of defects in material and/or workmanship at the time of retail purchase by the original purchaser. If the product is found to be defective, Curt Manufacturing Inc., may repair or replace the product, at their option, when the product is returned, prepaid, with proof of purchase. Alteration to, misuse of, or improper installation of this product voids the warranty. Curt Manufacturing Inc.'s liability is limited to repair or replacement of products found to be defective, and specifically excludes liability for incidental or consequential loss or damage.