

11517**77-89 BMW 6-SERIES COUPE**

12/10/2012

GROSS LOAD CAPACITY WHEN USED AS A WEIGHT CARRYING HITCH: 1,500 LBS. TRAILER WEIGHT & 150 LBS. TONGUE WEIGHT.

*****DO NOT EXCEED VEHICLE MANUFACTURER'S RECOMMENDED TOWING CAPACITY.*****

WARNING: ALL NON-TRAILER LOADS APPLIED TO THIS PRODUCT MUST BE SUPPORTED BY 18050 STABILIZING STRAPS.

**** FAILURE TO PROPERLY SUPPORT NON-TRAILER LOADS WILL VOID PRODUCT WARRANTY****

HAVING INSTALLATION QUESTIONS? CALL TECHNICAL SUPPORT AT 1-877-287-8634

Parts List			
ITEM	QTY	PART NUMBER	DESCRIPTION
1	1	1/2-13 x 1 3/4	HEX BOLT
2	1	FW12	FW, 12, ZP
3	1	1/2"	LOCK WASHER
4	1	1/2-13	HEX NUT
5	3	3/8 - 16 x 1 1/4	HEX BOLT
6	3	3/8"	FENDER WASHER
7	3	3/8"	LOCK WASHER
8	3	3/8 - 16	HEX NUT

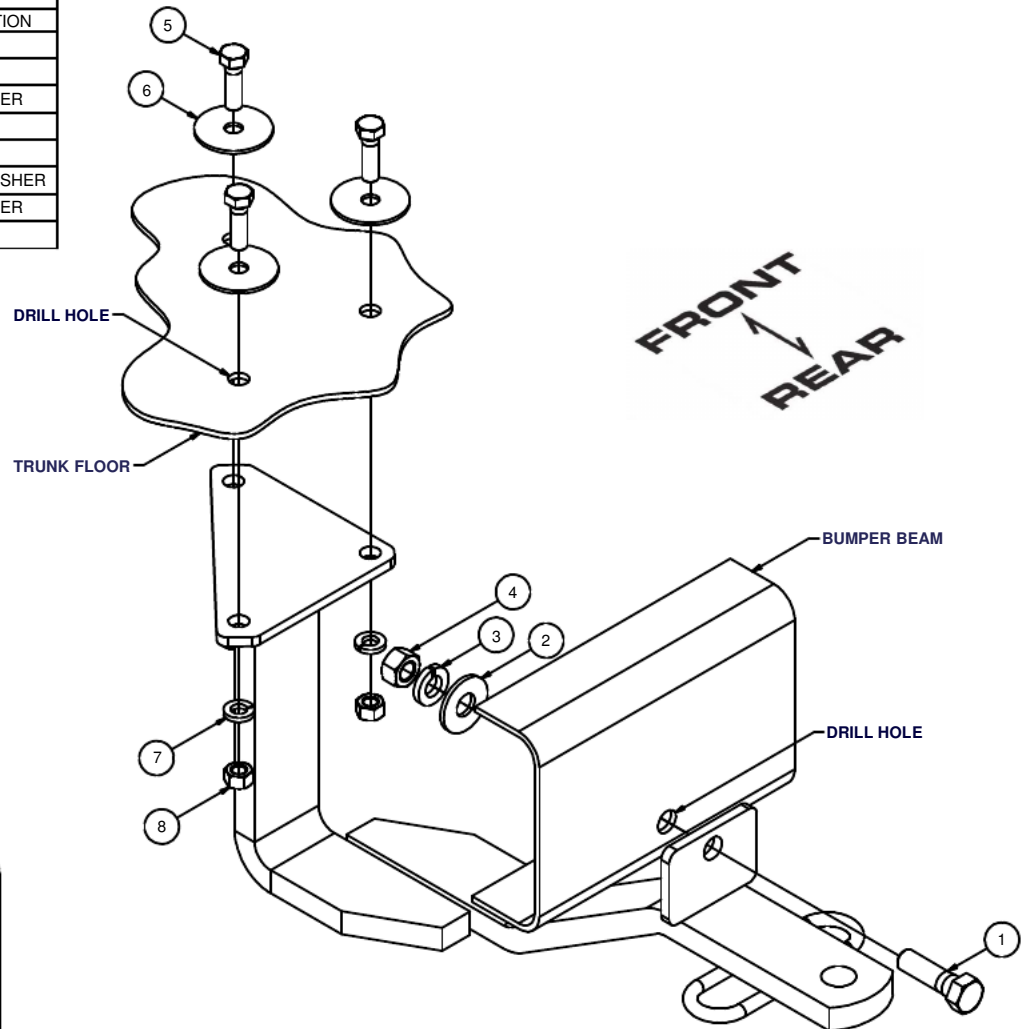

HITCH WEIGHT: 11 LBS.

INSTALL TIME

PROFESSIONAL: 30 MINUTES

NOVICE (DIY): 60 MINUTES

INSTALL NOTES:

- DRILLING REQUIRED
- EMPTY TRUNK
- SILICONE SEAL HARDWARE
- TRIMMING MAY BE REQUIRED

INSTALLATION STEPS

1. Empty the trunk including floor covering. Position the hitch on the car as shown in the diagram, centered and square with the car. Mark and drill metal bumper for 1/2" fasteners. Attention should be paid to provide clearance for nuts and washers inside the bumper beam. Bumper rubber strip may need to be trimmed slightly for bumper bracket.
2. Using the hitch as a template, mark and drill trunk floor for 3/8" fasteners. Install all fasteners as shown, making sure that fender washers are placed inside of the trunk opposite the hitch.
3. Torque all 3/8" fasteners to 45 lb-ft, and all 1/2" fasteners to 110 lb-ft.
4. Use silicone sealant to seal hardware installed through trunk floor.
5. Reinstall items removed in Step 1.

PERIODICALLY CHECK THIS RECEIVER HITCH TO ENSURE THAT ALL FASTENERS ARE TIGHT AND THAT ALL STRUCTURAL COMPONENTS ARE SOUND.

Curt Manufacturing Inc., warrants this product to be free of defects in material and/or workmanship at the time of retail purchase by the original purchaser. If the product is found to be defective, Curt Manufacturing Inc., may repair or replace the product, at their option, when the product is returned, prepaid, with proof of purchase. Alteration to, misuse of, or improper installation of this product voids the warranty. Curt Manufacturing Inc.'s liability is limited to repair or replacement of products found to be defective, and specifically excludes liability for incidental or consequential loss or damage.