

**11172****96-98 BMW 5 SERIES SEDAN**

11/30/2012

GROSS LOAD CAPACITY WHEN USED AS A WEIGHT CARRYING HITCH: 2,000 LBS. TRAILER WEIGHT &amp; 200 LBS. TONGUE WEIGHT.

**\*\*\*DO NOT EXCEED VEHICLE MANUFACTURER'S RECOMMENDED TOWING CAPACITY.\*\*\*****WARNING: ALL NON-TRAILER LOADS APPLIED TO THIS PRODUCT MUST BE SUPPORTED BY AUXILIARY STABILIZING STRAPS.****\*\* FAILURE TO PROPERLY SUPPORT NON-TRAILER LOADS WILL VOID PRODUCT WARRANTY\*\***

HAVING INSTALLATION QUESTIONS? CALL TECHNICAL SUPPORT AT 1-800-798-0813

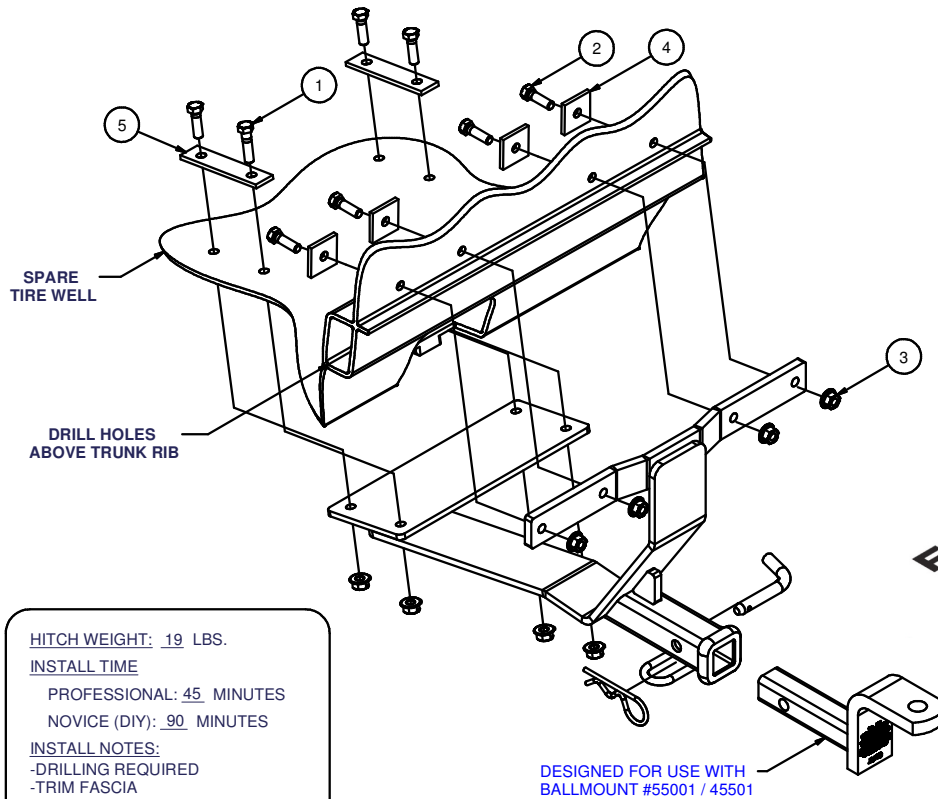

Parts List			
ITEM	QTY	PART NUMBER	DESCRIPTION
1	1	3/8-16 X 1 1/2	HEX BOLT
2	7	3/8 - 16 x 1 1/4	HEX BOLT
3	8	HFN3816	HEX FLANGE NUT
4	4	CM-SP123	.188 x 1.50 SPACER
5	2	CM-SP109	.188 x 1.00 SPACER

HITCH WEIGHT: 19 LBS.

INSTALL TIME

PROFESSIONAL: 45 MINUTES

NOVICE (DIY): 90 MINUTES

INSTALL NOTES:

- DRILLING REQUIRED
- TRIM FASCIA
- TEMPORARILY REMOVE SPARE TIRE

DESIGNED FOR USE WITH  
BALLMOUNT #55001 / 45501**INSTALLATION STEPS**

1. This hitch mounts to the trunk and tire well structure. Temporarily remove the spare tire from inside the tire well, and plastic trim panel at the inside rear of the trunk area. This panel is removed by removing (2) 6mm nuts, one on each side, and carefully pulling out the plastic clips.
2. Temporarily remove the rear bumper by unbolting (6) retaining nuts, (3) per side around the bumper mounting struts. Remove the fasteners attaching the bumper fascia to the tire well on both sides. Slide the bumper assembly rearward to remove it.
3. Temporarily unclip the wires from the retainers running along the lip inside the trunk area to be drilled. Position the hitch resting on the rear body ledge, centered to the left and right.
4. Using the hitch as a template, drill holes for fasteners in the upper part of the trunk. Install fasteners as shown. Be sure to install the backing plates inside the trunk as shown.
5. Using the hitch as a template, drill holes in lower part of trunk through trunk ribs. Install the backing plates inside the tire well as shown.
6. Torque all 3/8" fasteners to 45 lb-ft.
7. Trim bumper fascia to allow clearance for receiver hitch. Once cut reinstall bumper fascia back on to vehicle.

**PERIODICALLY CHECK THIS RECEIVER HITCH TO ENSURE THAT ALL FASTENERS ARE TIGHT AND THAT ALL STRUCTURAL COMPONENTS ARE SOUND.**

Curt Manufacturing Inc., warrants this product to be free of defects in material and/or workmanship at the time of retail purchase by the original purchaser. If the product is found to be defective, Curt Manufacturing Inc., may repair or replace the product, at their option, when the product is returned, prepaid, with proof of purchase. Alteration to, misuse of, or improper installation of this product voids the warranty. Curt Manufacturing Inc.'s liability is limited to repair or replacement of products found to be defective, and specifically excludes liability for incidental or consequential loss or damage.