



Safety glasses should be worn at all times while installing this product.

YEARS: 2011-CURRENT

MAKE: KIA

MODEL: FORTE

STYLE: HATCHBACK

WARNING: NEVER EXCEED YOUR VEHICLE MANUFACTURER'S RECOMMENDED TOWING CAPACITY





WEIGHT CARRYING:
 TRAILER WEIGHT: 2,000 LBS.
 TONGUE WEIGHT: 200 LBS.

WARNING:
 WE RECOMMEND THE USE OF 18050 STABILIZING STRAPS FOR ALL NON-TRAILER (WHEEL-LESS) LOADS. PLEASE SEE THE CURT CATALOG OR VISIT US ONLINE AT WWW.CURTMFG.COM FOR FURTHER INFORMATION.

INSTALLATION TIME: 45 MIN.

THE INSTALL TIME LISTED IS FOR PROFESSIONAL INSTALLERS. IF YOU ARE HESITANT TO UNDERTAKE THIS TASK ON YOUR OWN, CONTACT AN AUTHORIZED CURT INSTALLER FOR ADDITIONAL ASSISTANCE.



INSTALLATION REQUIRES:

 RATCHET	 3/4" 12mm 13mm 17mm SOCKET	 6" SOCKET EXTENSION
 TORQUE WRENCH		

INSTALLATION TIPS:

- BEFORE YOU BEGIN INSTALLATION, READ ALL INSTRUCTIONS THOROUGHLY.
- TO EASE INSTALLATION, 2 PEOPLE MAY BE REQUIRED.
- USING PROPER TOOLS WILL GREATLY IMPROVE THE QUALITY OF THE INSTALL AND REDUCE THE TIME REQUIRED.
- NEED HELP OR HAVE SOME QUESTIONS? CALL TECHNICAL SUPPORT AT 800.798.0813

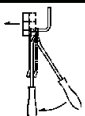
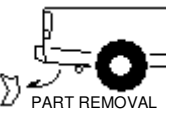
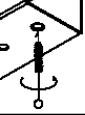
LEVEL OF DIFFICULTY: EASY

EASY	MODERATE	HARD
	LOWER EXHAUST	
	LOWER EVAPORATION CANISTER	
	CLEAN EXISTING WELDNUTS	
	NO DRILLING REQUIRED	

VEHICLE PHOTO:



REPRESENTATIVE PHOTO

HITCH ILLUSTRATION:

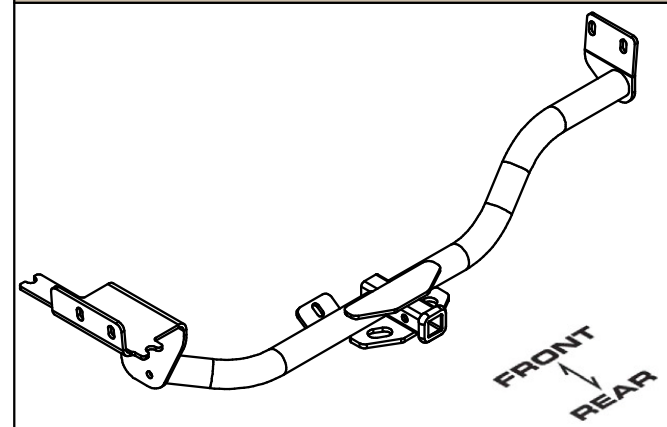

MAKE SURE YOUR HITCH MATCHES

PERIODICALLY CHECK THIS RECEIVER HITCH TO ENSURE ALL FASTENERS ARE TIGHT AND ALL STRUCTURAL COMPONENTS ARE SOUND

CURT Manufacturing Inc. warrants this product to be free of defects in material and/or workmanship at the time of retail purchase by the original purchaser. If the product is found to be defective, Curt Manufacturing Inc. may repair or replace the product at their option, when the product is returned, prepaid, with proof of purchase. Alteration to, misuse of, or improper installation of this product voids the warranty. Curt Manufacturing Inc.'s liability is limited to repair or replacement of products found to be defective, and specifically excludes liability for incidental or consequential loss or damage.

For more information log onto www.curtmfg.com, & for helpful towing tips log onto www.hitchinfo.com

INSTALLATION WALKTHROUGH:

Parts List			
ITEM	QTY	PART NUMBER	DESCRIPTION
1	4	M10 - 1.25 x 25	HEX BOLT
2	4	7/16"	CONICAL TOOTHED WASHER
3	1	CM-SP4	.250 x 1.50 x 3.00" SQUARE HOLE SPACER
4	1	1/2-13 x 1 3/4	CARRIAGE BOLT
5	1	HFN 1213	HEX FLANGE NUT
6	2	M8 - 1.25 x 30 HEX BOLT	HEX HEAD BOLT
7	2	5/16"	LOCK WASHER

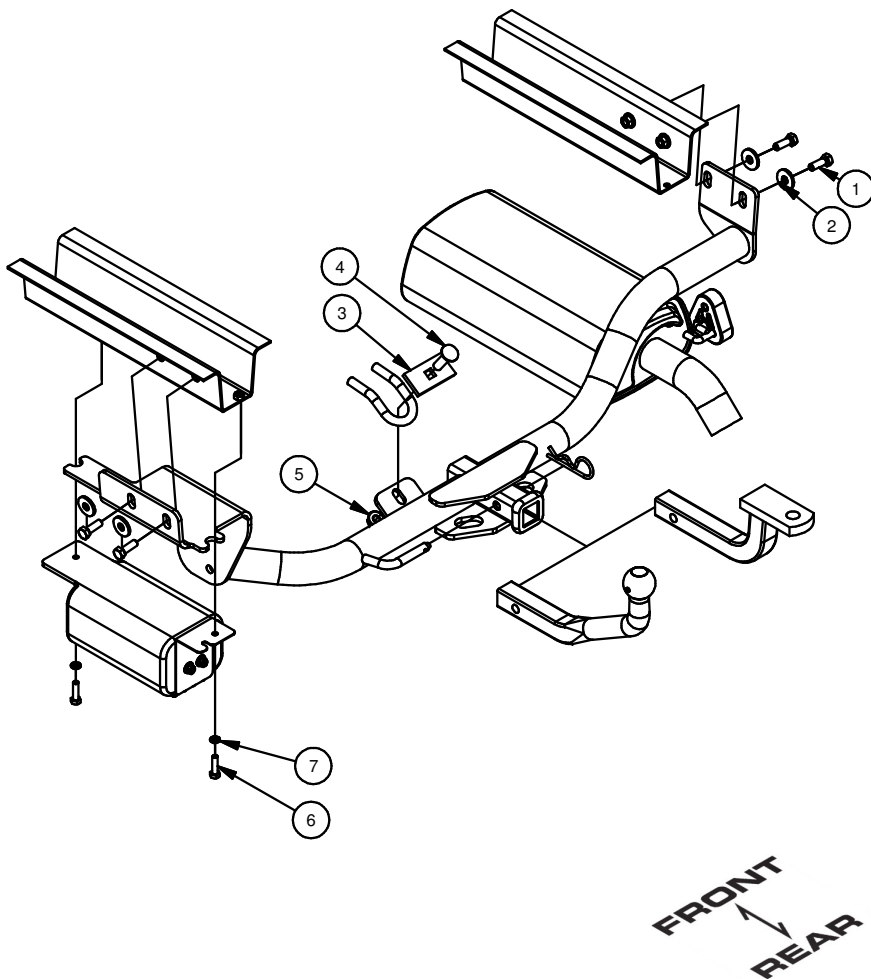

1. Lower exhaust by removing (2) rubber isolators.



2. Lower evaporation canister on driver side of vehicle by removing (2) hex bolts and slide the canister off of the (2) yellow clips. Remove the yellow clips from the frame rail. Return clips and bolts to vehicle owner.



INSTALLATION WALKTHROUGH:

3. Insert 1/2" carriage bolt and CM-SP40 spacer through the vehicle tow loop. Raise the hitch into position.



4. Secure hitch with supplied M10 hex bolts and 7/16" conical toothed washers. Install 1/2" hex flange nut onto carriage bolt.



5. Reinstall evaporation canister with supplied M8 hex bolts and 5/16" lock washers. Torque 1/2" hardware to 110 lb-ft., M10 hardware to 48 lb-ft and M8 hardware to 23 lb-ft.



6. Raise exhaust back into position.



GROSS LOAD CAPACITY WHEN USED AS A WEIGHT CARRYING HITCH: 2,000 LBS. TRAILER WEIGHT & 200 LBS. TONGUE WEIGHT.

*****DO NOT EXCEED VEHICLE MANUFACTURER'S RECOMMENDED TOWING CAPACITY.*****

WARNING: ALL NON-TRAILER LOADS APPLIED TO THIS PRODUCT MUST BE SUPPORTED BY 18050 STABILIZING STRAPS.

**** FAILURE TO PROPERLY SUPPORT NON-TRAILER LOADS WILL VOID PRODUCT WARRANTY****

HAVING INSTALLATION QUESTIONS? CALL TECHNICAL SUPPORT AT 1-800-798-0813

Parts List			
ITEM	QTY	PART NUMBER	DESCRIPTION
1	4	M10 - 1.25 x 25	HEX BOLT
2	4	7/16"	CONICAL TOOTHED WASHER
3	1	CM-SP4	.250 x 1.50 x 3.00" SQUARE HOLE SPACER
4	1	1/2-13 x 1 3/4	CARRIAGE BOLT
5	1	HFN 1213	HEX FLANGE NUT
6	2	M8 - 1.25 x 30 HEX BOLT	HEX HEAD BOLT
7	2	5/16"	LOCK WASHER

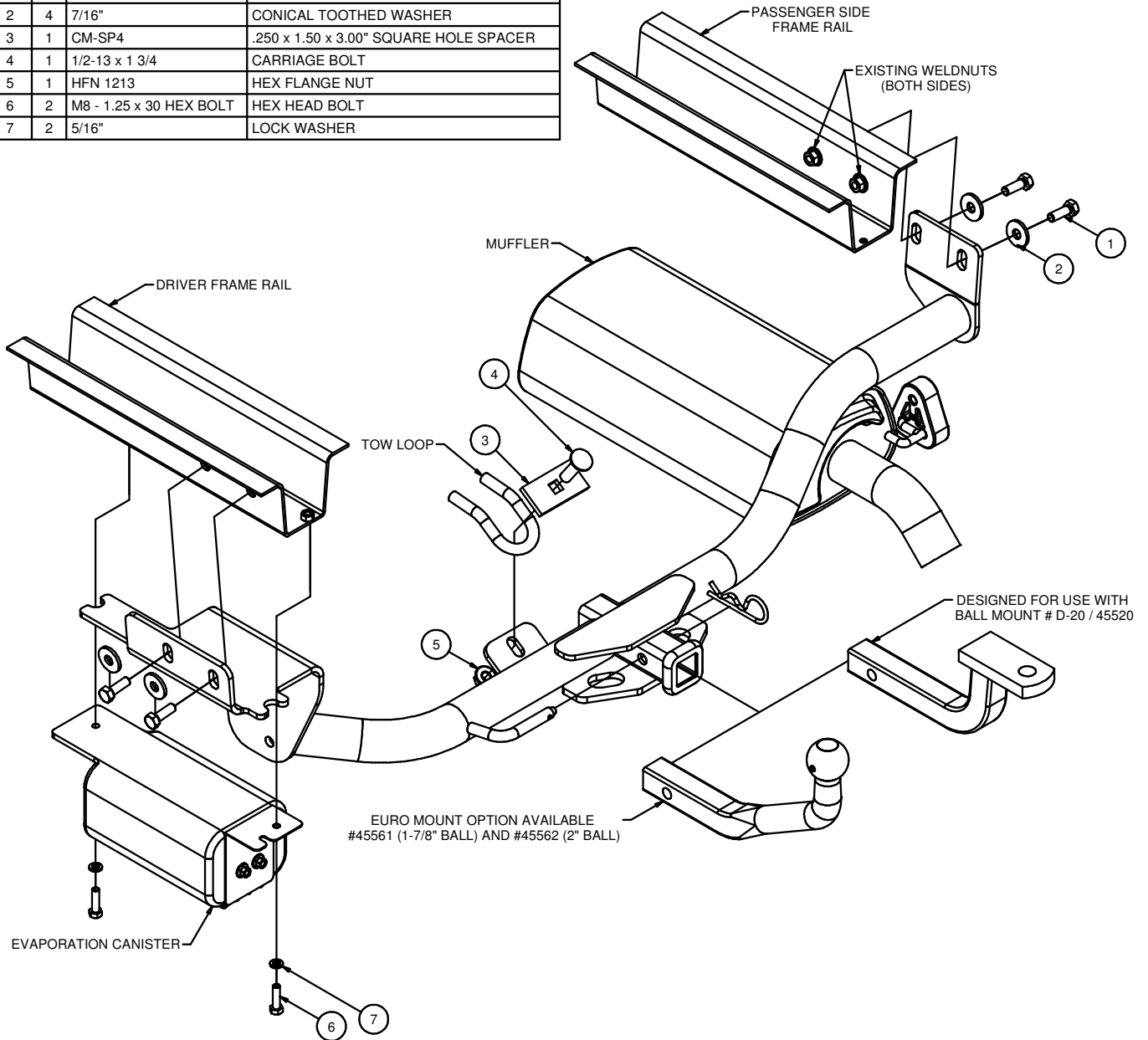

HITCH WEIGHT: 32 LBS.
INSTALL TIME
 PROFESSIONAL: 45 MINUTES
 NOVICE (DIY): 90 MINUTES
INSTALL NOTES:
 - NO DRILLING REQUIRED
 - LOWER EXHAUST
 - LOWER EVAPORATION CANISTER

PERIODICALLY CHECK THIS RECEIVER HITCH TO ENSURE THAT ALL FASTENERS ARE TIGHT AND THAT ALL STRUCTURAL COMPONENTS ARE SOUND.

Curt Manufacturing Inc., warrants this product to be free of defects in material and/or workmanship at the time of retail purchase by the original purchaser. If the product is found to be defective, Curt Manufacturing Inc., may repair or replace the product, at their option, when the product is returned, prepaid, with proof of purchase. Alteration to, misuse of, or improper installation of this product voids the warranty. Curt Manufacturing Inc.'s liability is limited to repair or replacement of products found to be defective, and specifically excludes liability for incidental or consequential loss or damage.

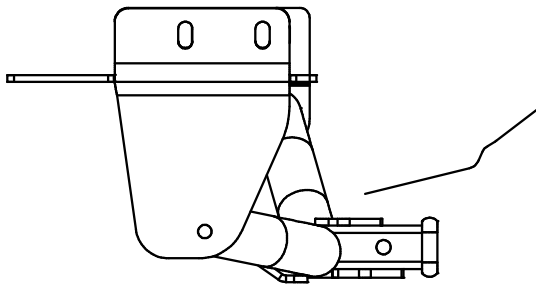
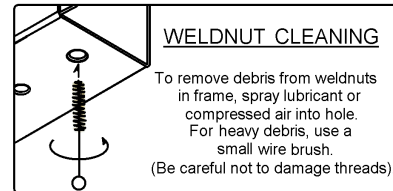
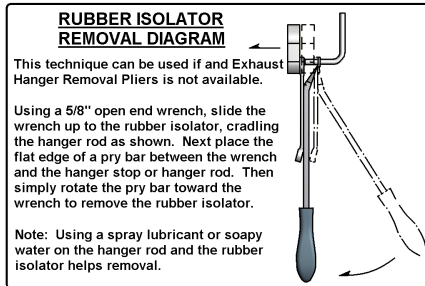

INSTALLED HITCH POSITION

TOOLS REQUIRED
RATCHET
6" EXTENSION
12mm SOCKET
13mm SOCKET
17mm SOCKET
3/4" SOCKET
TORQUE WRENCH

INSTALLATION STEPS

1. Lower exhaust by removing (2) rubber isolators.
2. Lower evaporation canister on driver side of vehicle by removing (2) hex bolts. Remove canister by sliding off of yellow plastic hangers. Return bolts to vehicle owner.
3. Remove yellow plastic clips from driver side frame rail. Return clips to vehicle owner.
4. Install 1/2" carriage bolt and CM-SP40 spacer through vehicle tow loop.
4. Raise hitch into position and secure with M10 bolts and 7/16" conical toothed washers into existing weldnuts. Install 1/2" hex flange nut onto carriage bolt.
5. Raise evaporation canister and secure with supplied M8 bolts and 5/16" lock washers.
6. Torque 1/2" hardware to 110 lb-ft, M10 hardware to 48 lb-ft and M8 hardware to 23 lb-ft.
7. Raise exhaust back into position.

PERIODICALLY CHECK THIS RECEIVER HITCH TO ENSURE THAT ALL FASTENERS ARE TIGHT AND THAT ALL STRUCTURAL COMPONENTS ARE SOUND.