

INSTALLATION INSTRUCTIONS AND PARTS LIST

MODEL 583072, 583078, 583088, 584072, 584078, 584088 O-MEGA II 6" OVAL STEPS
UNIVERSAL APPLICATION

1. READ INSTRUCTIONS COMPLETELY AND CHECK TO MAKE SURE THAT ALL REQUIRED PARTS (LISTED ON THE SERVICE PARTS LIST) ARE ON HAND BEFORE STARTING THE INSTALLATION.
2. FOLLOW THE INSTRUCTIONS INCLUDED WITH THE SPECIFIC BRACKET PACKAGE THAT YOU ARE USING, TO MOUNT THE BRACKETS TO YOUR VEHICLE.
3. BEFORE ATTACHING THE O-MEGA STEPS TO THE BRACKETS, PLACE THE STEP PADS (ITEM #2) ON TOP OF THE STEP PLATES. USE THE TABLE ON SHEET #2, AS A GUIDE TO POSITION THE STEP PAD FOR YOUR PARTICULAR VEHICLE. WHEN INSTALLING THE PADS ON THE STEPS, DRILL (5) 1/8" HOLE USING THE STEP PAD AS A GUIDE. ATTACH WITH (5) 8-18X1/2" TEK SCREWS (ITEM #6) PROVIDED. REPEAT FOR ALL STEP PADS.
4. INSTALL THE REQUIRED NUMBER OF SQUARE HEAD BOLTS INTO THE DESIGNATED SLOTS IN THE BOTTOM OF THE STEP PLATES.
5. INSTALL THE END CAPS (ITEM #3) AS SHOWN IN *fig. 1*, TIGHTENING THE NUTS TO 5 LB FT.
6. POSITION THE O-MEGA STEP ON THE MOUNTING BRACKETS SO THAT THE SQUARE HEAD SCREWS (ITEM #4) ARE LOCATED IN THE SLOTS OF THE MOUNTING BRACKETS AND THE STEP IS CENTERED, FRONT TO REAR, ON THE VEHICLE. INSTALL 5/16" SERRATED FLANGE NUTS (ITEM #5) ON THE SQUARE HEAD SCREWS (ITEM #4) AND TIGHTEN TO 19 LB FT.

SERVICE PARTS LIST

ITEM	PART NO.	QTY	DESCRIPTION
1	553071	2	EXTRUSION-AL,69.0,OMEGA STP,SILVER
1	553072	2	EXTRUSION-AL,75.0,OMEGA STP,SILVER
1	553073	2	EXTRUSION-AL,85.0,OMEGA STP,SILVER
1	553059	2	EXTRUSION-AL,69.0,OMEGA STP,BLACK
1	553060	2	EXTRUSION-AL,75.0,OMEGA STP,BLACK
1	553061	2	EXTRUSION-AL,85.0,OMEGA STP,BLACK
2	552970	4	ALUM,STP-PAD,BLK,OMEGA-STEP
3	107956	4	CAP-END,PLSTC,2.95 X 6.70
4	106880	24	SCREW-SQ HD,5/16-18 X 1,MAGNIGUARD
5	102680	24	NUT-SERR FLG,HX,SST,WX,5/16-18
6	107958	20	SCREW-PPH,TEK,#8-18 X 1/2",SST,BZP



STEP PAD LOCATION GUIDE

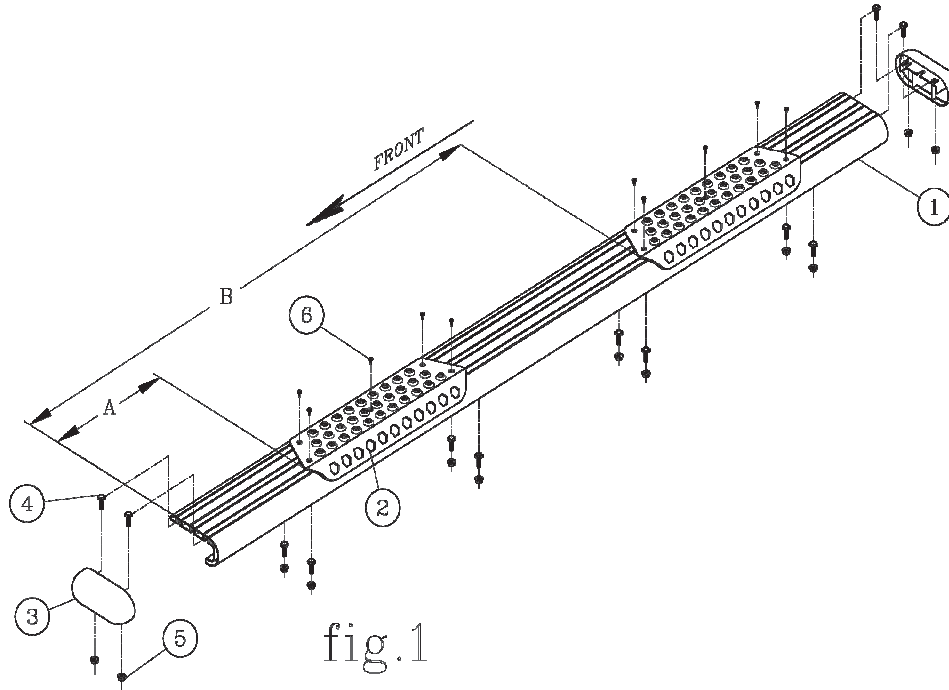

VEHICLE MODEL	PAD A	PAD B
SILVERADO/SIERRA DOUBLE CAB	14-3/4	46-3/4
SILVERADO/SIERRA EXTENDED CAB	14-3/4	41-3/4
SILVERADO/SIERRA CREW CAB	14-3/4	54-1/4
COLORADO/CANYON EXTENDED CAB	10-1/2	43
COLORADO/CANYON CREW CAB	10-1/2	51
AVALANCHE/SUBURBAN/YUKON XL	15-1/4	55-1/4
TAHOE/YUKON	15-1/4	48-1/4
RAM QUAD CAB	10-1/2	46
RAM CREW CAB	10-1/2	48
RAM MEGA CAB	10-1/2	52-1/16
DODGE DAKOTA QUAD CAB	10-1/2	39
DODGE DURANGO	15-1/4	50-1/4
FORD F150 SUPER CAB	18-1/4	46-1/4
FORD F150 SUPER CREW CAB	18-1/4	56-1/2
FORD SUPER DUTY SUPER CAB	14-1/4	42
FORD SUPER DUTY CREW CAB	12	58-1/4
TOYOTA TUNDRA DOUBLE CAB 07+	8-1/4	49-1/4
TOYOTA TUNDRA CREWMAX07+	8-1/4	54-1/4
TOYOTA TACOMA ACCESS CAB	8-1/4	30-1/5
TOYOTA TACOMA DOUBLE CAB	18-3/4	55-1/4

NOTE: THE ABOVE PAD LOCATIONS ARE ONLY SUGGESTIONS AND MAY BE PLACED AT THE PURCHASERS DISCRETION.



INSTALLATION INSTRUCTIONS AND PARTS LIST

APPLICATION: MODEL 571747 MEGA STEP BRACKETS ON:
2015+ GM 2500/3500HD PICKUPS, GAS/DIESEL
BODY MOUNT APPLICATION



NO DRILL APPLICATION

1. READ INSTRUCTIONS COMPLETELY AND CHECK TO MAKE SURE THAT ALL REQUIRED PARTS (LISTED ON SERVICE PARTS LIST) ARE ON HAND BEFORE STARTING THE INSTALLATION.
2. ON THE LEFT SIDE OF THE VEHICLE PREASSEMBLE THE FRONT BRACKET (ITEMS #2, 4) AS SHOWN IN **FIG. 1** USING THREE 3/8"-16 X 1.0" SCREWS, 3/8" FLAT WASHER AND 3/8" FLANGE NUTS (ITEMS #13, 19, 11). TORQUE TO 19 LB. FT. **NOTE: IF INSTALLING ON A 1500 PICKUP YOU MUST ATTACH THE SMALL 90° BRACKET (ITEM #14) TO THE FRONT BRACKETS (SEE FIG 1.)**
3. ASSEMBLE THE LOAD REACTION STUDS AND HARDWARE (ITEMS #10, 11, 12, 19) AS FOLLOWS.
 - 3.1. ON THE SHORT THREADED END OF THE LOAD REACTION STUD (ITEM #12), INSTALL A 3/8" SERRATED FLANGE NUT (ITEM #11) BACKWARDS TO THE BOTTOM OF THE THREAD. THEN INSTALL A 3/8" FLAT WASHER (ITEM #19) AND RUBBER "CUSHION" WASHER (ITEM # 10) TIGHT UP AGAINST THE SERRATED FLANGE NUT. (THE END OF THE STUD MUST BE RECESSED IN THE RUBBER WASHER APPROX. 3/16").
 - 3.2. ON THE LONG THREADED END OF THE STUD, INSTALL A 3/8" SERRATED FLANGE NUT (ITEM #11) BACKWARDS TO NEAR TO THE BOTTOM OF THE THREADS
4. ATTACH THE LOAD REACTION STUD ASSEMBLIES TO THE MOUNTING BRACKETS AS SHOWN IN **FIG. 4**. INSERT THE STUD, FROM WHAT WILL BE THE INBOARD OR FRAME SIDE THRU THE LOWEST HOLE IN THE BENT FLANGE OF THE BRACKET THAT WILL ALLOW THE RUBBER WASHER TO SEAT FIRM AGAINST THE SIDE WALL OF THE FRAME. INSTALL A 3/8" SERRATED FLANGE NUT (ITEM #11) ON THE OUTBOARD END OF THE STUD (FINGER TIGHT ONLY).

NOTE:

DUE TO EXCESSIVE THREAD LOCKER IN THE BODY MOUNT BOLT AREA ON THE 2010+ GM SILVERADO/SIERRA, USE CAUTION WHEN REMOVING THE BODY MOUNT BOLTS.

5. REMOVE THE FACTORY FRONT, CENTER, AND REAR BODY MOUNT BOLTS AND INSTALL THE MOUNTING BRACKETS PER THE FOLLOWING INSTRUCTIONS:
 - 5.1. INSTALL THE FRONT MOUNTING BRACKET (ITEMS #2, 4) TO THE FRONT BODY MOUNT AS SHOWN (LEAVE THESE FASTENERS FINGER TIGHT).
 - 5.2. INSTALL THE CENTER MOUNTING BRACKET (ITEM #5) TO THE CENTER BODY MOUNT AS SHOWN (LEAVE THESE FASTENERS FINGER TIGHT).
 - 5.3. INSTALL THE REAR MOUNTING BRACKET (ITEM #9) & WASHER (ITEM #15) TO THE REAR BODY MOUNT AS SHOWN (LEAVE THESE FASTENERS FINGER TIGHT).
 - 5.4. ATTACH THE REAR OUTBOARD MTG BRKT (ITEM #7) TO THE REAR INBOARD MTG BRKT (ITEM #9), USING THREE 3/8"-16 X 1.0" SCREWS, 3/8" FLAT WASHERS AND 3/8" FLANGE NUTS. (ITEMS #13, 19, 11). THE REAR OUTBOARD MOUNTING BRACKET MUST BE MOUNTED TO THE BACK SIDE OF THE REAR INBOARD MOUNTING BRACKET (TOWARDS THE REAR OF THE VEHICLE) AS SHOWN IN FIG 2 AND 3. BE SURE TO USE THE CORRECT HOLES AS SHOWN IN FIG. 2 & 3. NOTE THAT THERE IS A DIFFERENCE BETWEEN THE DOUBLE CAB AND CREW CAB APPLICATIONS. TORQUE THE BOLTS TO 19 LB. FT.

6. ATTACH THE SPRING HANGER MOUNTING BRACKETS (ITEM# 16, 17) AGAINST THE SIDE OF THE VEHICLE SPRING HANGER AS SHOWN.
 - 6.1 LOOSEN THE SPRING HANGER BOLT JUST ENOUGH SO THAT THE INBOARD SPRING HANGER MOUNTING BRACKET (ITEM #16) CAN BE SLID UP BEHIND THE FLANGE OF THE BOLT. POSITION THE INBOARD SPRING HANGER MOUNTING BRACKET BEHIND THE FLANGE OF THE SPRING HANGER BOLT, WITH THE CHANNEL OPEN TO THE OUTBOARD SIDE, AS SHOWN.
 - 6.2 USING A 3/8"-16 BOLT, 3/8" WASHER, 1/2" WASHER AND 3/8" LOCK NUT (ITEMS# 19-21) INSTALL THE OUTBOARD SPRING HANGER MOUNTING BRACKET (ITEM #17) SO THAT THE INBOARD VERTICAL PORTION OF THE BRACKET FITS INSIDE THE CHANNEL SHAPE OF THE INBOARD SPRING HANGER BRACKET. LEAVE THESE FASTENERS FINGER TIGHT AT THIS TIME.
7. INSTALL THE STEP BOARDS AS DESCRIBED BY THE INSTRUCTIONS INCLUDED WITH YOUR STEP BOARDS. (NOTE: INSURE THAT THE MOUNTING BRACKETS DO NOT TOUCH THE INSIDE WALL OF THE BODY MOUNT HOUSING AND TORQUE THE BODY MOUNT FASTENERS TO MANUFACTURES SPECS).
8. POSITION THE LOAD REACTION BOLT ASSEMBLY SO THAT THE RUBBER CUSHION IS SNUG UP AGAINST THE SIDE OF THE FRAME. TIGHTEN THE 3/8" FLANGE NUTS ON EITHER SIDE OF THE BRKT TO 19LB. FT.
9. REPEAT STEPS 1-7 FOR THE RIGHT SIDE OF THE VEHICLE.

SERVICE PARTS LIST

ITEM	PART NO.	QTY	DESCRIPTION
1		1	STEP ASSY, MEGA STEP / O-MEGA STEP
2	552646	1	BRACKET-MTG, FRONT, LH, MEGA STEP, 571743
3	553123	1	BRACKET-MTG, FRONT, RH, MEGA STEP, 571743
4	552718	2	BRACKET-MTG, FRONT, INBOARD, 571743
5	552648	1	BRACKET-MTG, CENTER, LH, MEGA STEP, 571743
6	552647	1	BRACKET-MTG, CENTER, RH, MEGA STEP, 571743
7	552650	1	BRACKET-MTG, REAR, LH, MEGA STEP, 571743
8	552649	1	BRACKET-MTG, REAR, RH, MEGA STEP, 571743
9	551907	2	BRACKET-MTG, REAR, INBOARD, LH/RH, 571743
10	102592	6	WSHR, RUBBER, .354 ID X 1.00 OD X .75 THK
11	100181	30	NUT, SERR FLG, HEX, 3/8-16 UNC, ZP
12	104686	6	STUD, -DBL ENDED, STL, 3/8-16 X 4.00", ZP
13	100040	12	SCR-HEX HD, 3/8-16 UNC, ZP
14	551571	2	BRACKET-90 DEGREE, 3 HOLE
15	108882	2	WSHR, FL, .59 ID X 1.06 OD X .19 THK, ZP
16	551806	2	BRKT-MTG, REAR, INBOARD
17	552717	2	BRKT-MTG, REAR, OUTBOARD
18	101326	2	SCREW - HEX HEAD, 3/8"-16 X 2", ZP
19	100062	22	WASHER - FLAT, 3/8", ZP
20	100118	4	WASHER - FLAT, 1/2", ZP
21	102381	2	NUT-SELF LOCKING, 3/8"-16, ZP

CURT Group Recommendation: CURT Group recommends regular inspection and maintenance of the leaf spring attachment point per GM Technical Service Bulletin 09-03-09-001E: Clunking Noise from Rear of Vehicle (Re-torque Leaf Spring Bolts) - 2007-2017 Chevrolet GMC Trucks. Failure to regularly inspect and maintain factory-recommended torque values may result in damage to the vehicle.



FIG. 1

GM REGULAR CAB W2W

#14 IS USED
ON 1500 MODELS ONLY

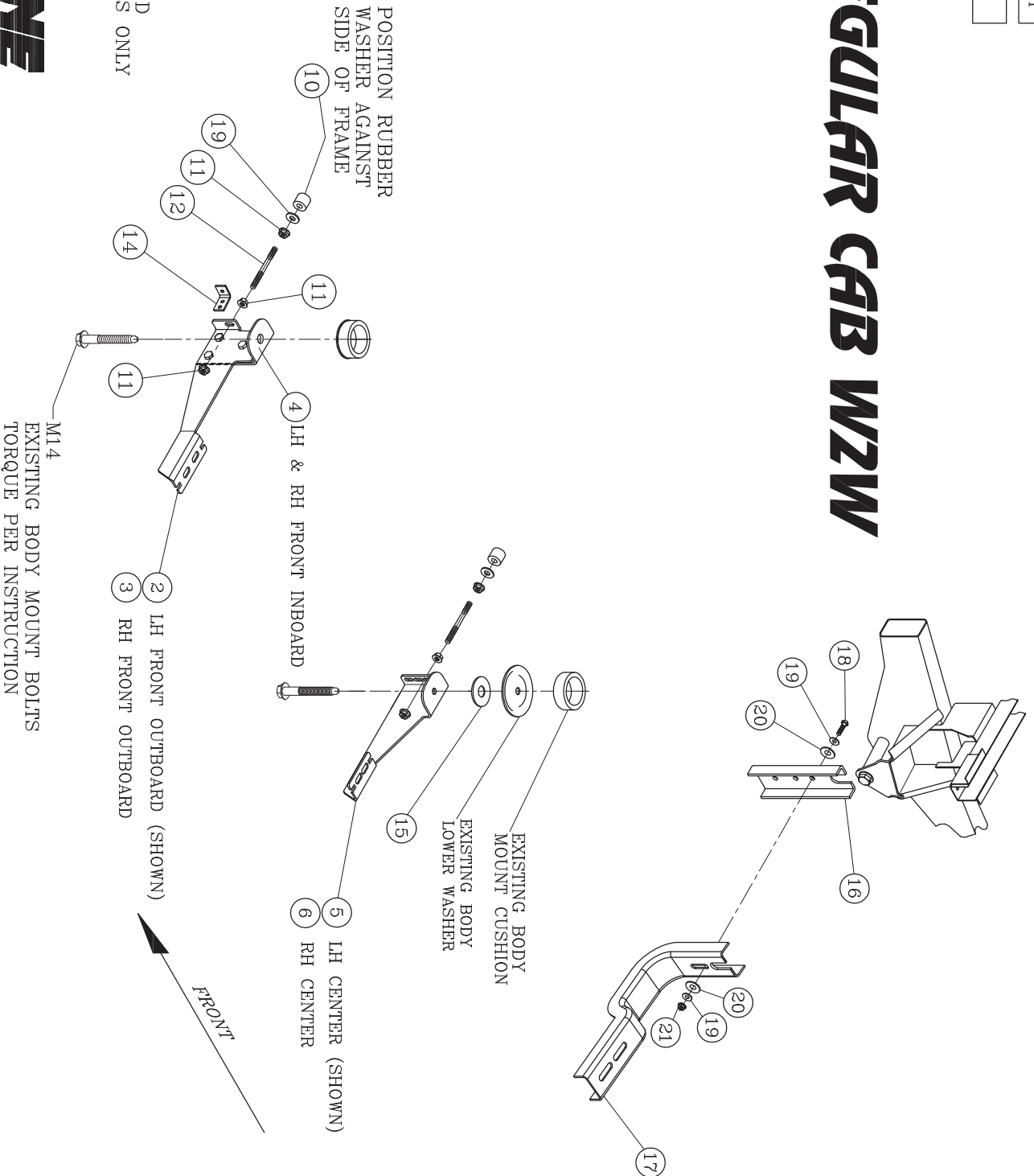

EXISTING BODY MOUNT BOLTS
TORQUE PER INSTRUCTION

LEFT (DRIVER) SIDE SHOWN
-RIGHT (PASSENGER) SIDE OPPOSITE-



SERVICE PARTS LIST

MODEL NO. 571747

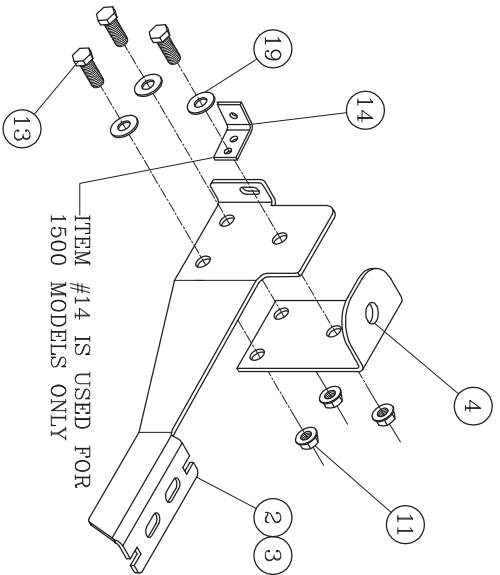

FRONT BRACKET
ASSEMBLY

FIG. 1

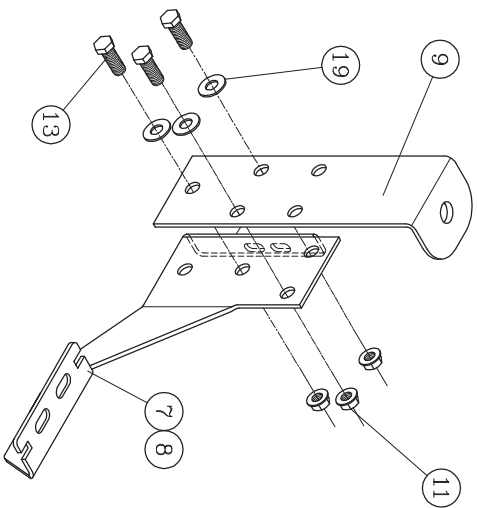

DOUBLE CAB
REAR BRACKET
ASSEMBLY

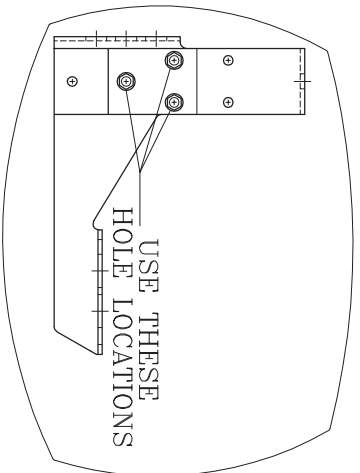
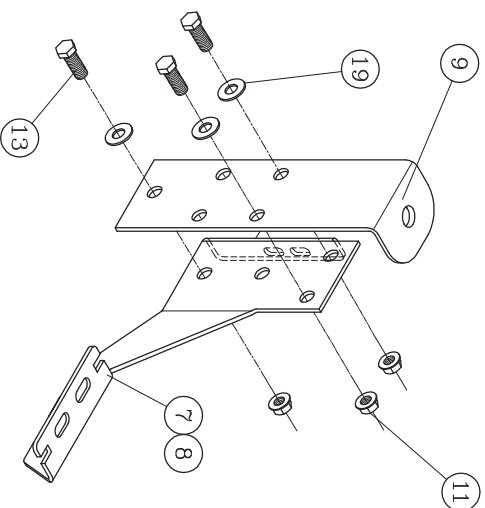

FIG. 2



CREW CAB
REAR BRACKET
ASSEMBLY

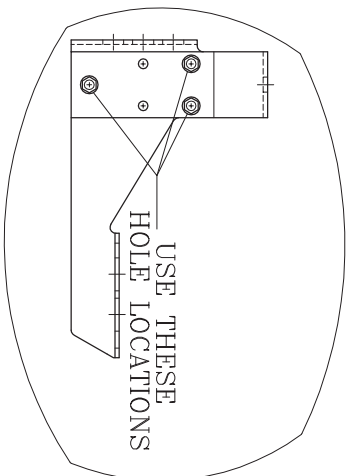
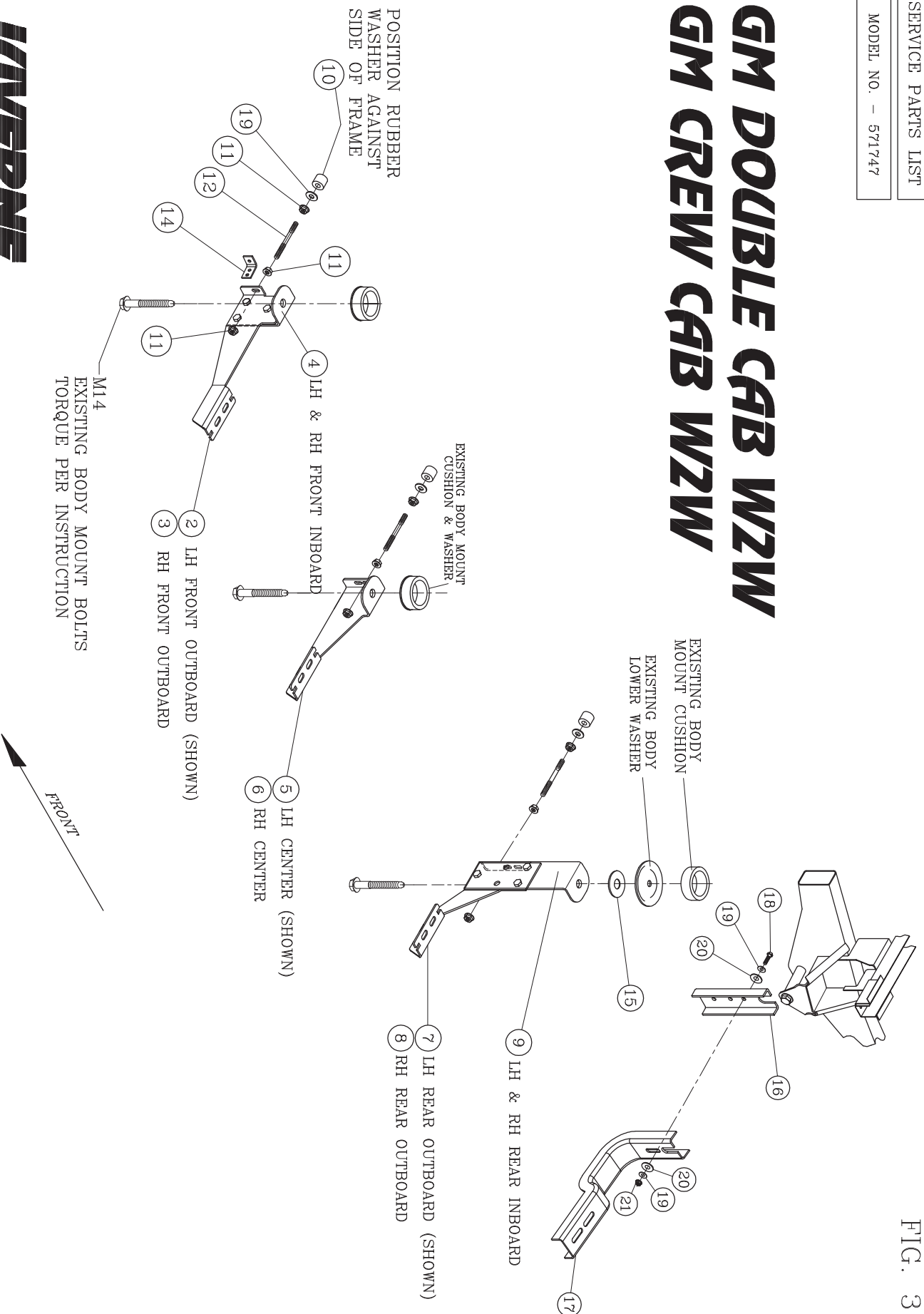

FIG. 3



FIG. 3

GM DOUBLE CAB W2W GM CREW CAB W2W



LEFT (DRIVER) SIDE SHOWN
-RIGHT (PASSENGER) SIDE OPPOSITE-