

## INSTALLATION MANUAL

**571724**

Mega/Omega Step Bracket kit  
2015+ Ford Transit Van Long\Long

### Parts List

3	Front Mounting Bracket
2	Middle Mounting Bracket
1	Rear Mounting Bracket
1	AC Mounting Bracket
1	AC Top Mounting Bracket
3	U-Bolt 3"
2	U-Bolt 3.75"
4	Spacer
13	Bolt Retainer
16	Lock Washer, 5/16
13	Flange Nut M8
16	Hex Bolt, M8
2	Thread Cutting Bolt 5/16
2	Washer,5/16
14	Clip Nut M8

### Level of Difficulty

Easy

### Product Image



Front Mounting Bracket (553204)



Middle Monting Bracket (553206)



Rear Mounting Bracket (553208)

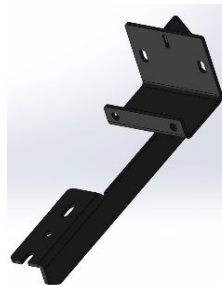

AC Mounting Bracket (553211)

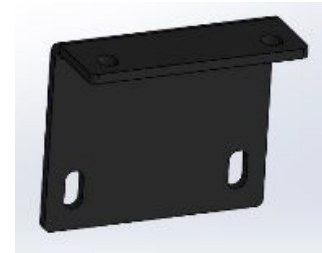

AC Top Mounting Bracket (553212)

### Notes and Maintenance

Before you begin installation, read all instructions thoroughly.

Make sure all required parts are on hand before starting the installation.

### Tools Required

Socket, 1/2"	Ratchet
Wrench, 1/2"	Drill
Flat Screwdriver	Drill Bit, 3/8"
Marker	Drill Bit, 3/32
Putty Knife	Drill Bit, 19/64

**Step 1**

Starting on the Passanger side, locate mounting locations as shown in Fig 1 and Fig 3.

Hold each bracket in its mounting locations and mark each hole on the rocker and pinch weld.

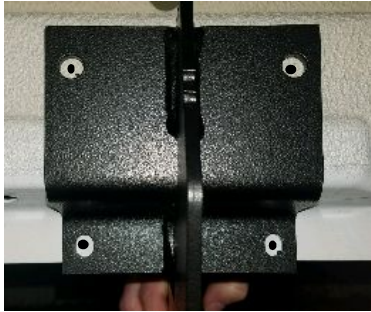

**Step 2**

From the under side of the plastic rocker molding use a flat head screw drive to release the bottom push pins.

**NOTE: Do not remove plastic trim all the way only release the bottom push pins.**



**Step 3**

Starting on the first bracket using a 3/32" drill bit, drill a pilot hole in each of the marked spots followed by a 3/8" drill bit.

**NOTE: Place a Putty knife between the pinch weld and the plastic rocker molding to avoid damaging molding from drilling.**



**Step 4**



Using the 3" U-Bolt put it through the top 2 mounting holes and secure with (2) plastic bolt retainer.

Slide (2) Clip Nuts on the pinch weld for the bottom mounting locations.

Slide the front mounting bracket on the U-Bolts and secure with (2) 5/16 flat washers (2) 8mm nuts on the studs, and (2) 5/16 lock washer and (2) 8mm bolts in the clip nuts.

Leave all brackets loose until the end.

**Repeat for 2nd bracket**

**Step 5**

Move to the 3rd & 4th mounting brackets, **models with factory studs** will use those as mounting locations. **Models with out factory studs** will have holes pre drilled in the rocker panel and will use the 3.75" U-Bolts with the plastic bolt retainer.



**Repeat steps 3&4 for the bottom mounting Holes.**

**Step 6**



Continue along the side of the vehicle to the 5th mounting bracket repeat steps 3, 4 for the lower mounting holes.

Insert the 8mm T-bolt weldment with a plastic retainer clip to secure it in place.

Slide the rear mounting bracket on the T-Bolts and secure with (1) 8mm nuts and (2) 8mm bolts.

**NOTE: Leave all brackets loose until the end**

**Step 7**

Moving to the driver side, locate mounting locations using Fig 2 and Fig 4.

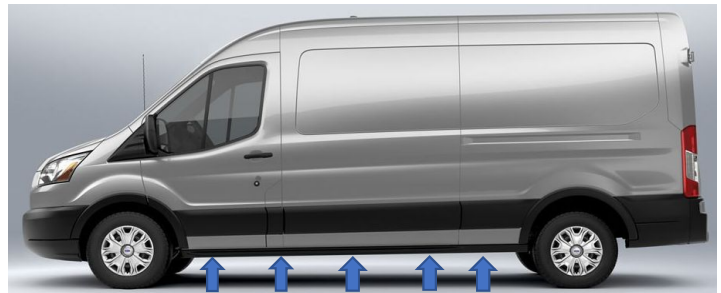

**Step 8**



Repeat steps 1-4 to install **1st bracket.**



Step 9

Assemble the AC bracket using the (2) M8 Bolts, (2) 5/16 washers, (2) M8 nuts.



Step 10



After assembling the AC bracket place along the pinch seam using Fig. 2 and Fig. 4 marking the 4 hole locations

Step 11

Drill the 2 upper holes with a 19/64 drill bit and the bottom 2 with a 3/8 drill bit

**NOTE: THE 2 TOP HOLES WILL USE SELF THREADING BOLTS.**

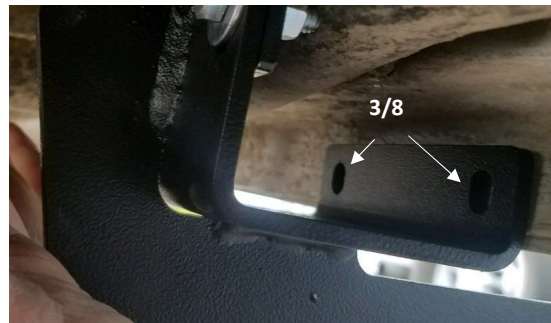

Step 12



Slide 2 clip nuts on the pinch weld for lower holes attach the AC bracket using (2) 8MM Bolts and (2) 5/16 Lock Washers on the bottom Clip Nuts and (2) 5/16 Thread Cutting Bolt and (2) 5/16 lock washers on the upper holes

Step 13

**Leave ALL brackets Loose at this time. Please Review the installation instructions that are included in your step assembly for specific details. Place step board on brackets tighten all brackets so the board is level.**

**PARTS LIST  
FOR MOUNTING 571724 MEGA STEP BRACKETS  
2015 AND NEWER FORD TRANSIT VAN**

**SERVICE PARTS LIST**

<b>ITEM</b>	<b>PART NO.</b>	<b>QTY</b>	<b>DESCRIPTION</b>
1	553204	3	FRONT MOUNTING BRACKET
2	553206	2	MIDDLE MOUNTING BRACKET
3	553208	1	REAR MOUNTING BRACKET
4	553211	1	AC MOUNTING BRACKET
5	553212	1	AC TOP MOUNTING BRACKET
6	101795	3	U-BOLT 3.00
7	101796	2	U-BOLT 3.75
8	107182	4	WSHR-SPCR, NYL, BLK
9	101572	13	BOLT RETAINER
10	100030	16	5/16 LOCK WASHER
11	100034	8	5/16 WASHER
12	105859	13	M8 FLANGE NUT
13	102549	16	M8 HEX BOLT
14	101566	14	M8 CLIP NUT
15	109177	2	5/16 THREAD CUTTING BOLT
16	553221	1	T-BOLT WLDMNT



SERVICE PARTS LIST

BRACKET NO. - 571724

IDENTIFICATION NOTCHES  
IN BRACKET(S) #553208

FIG. 1

IDENTIFICATION NOTCHES  
IN BRACKET(S) #553206

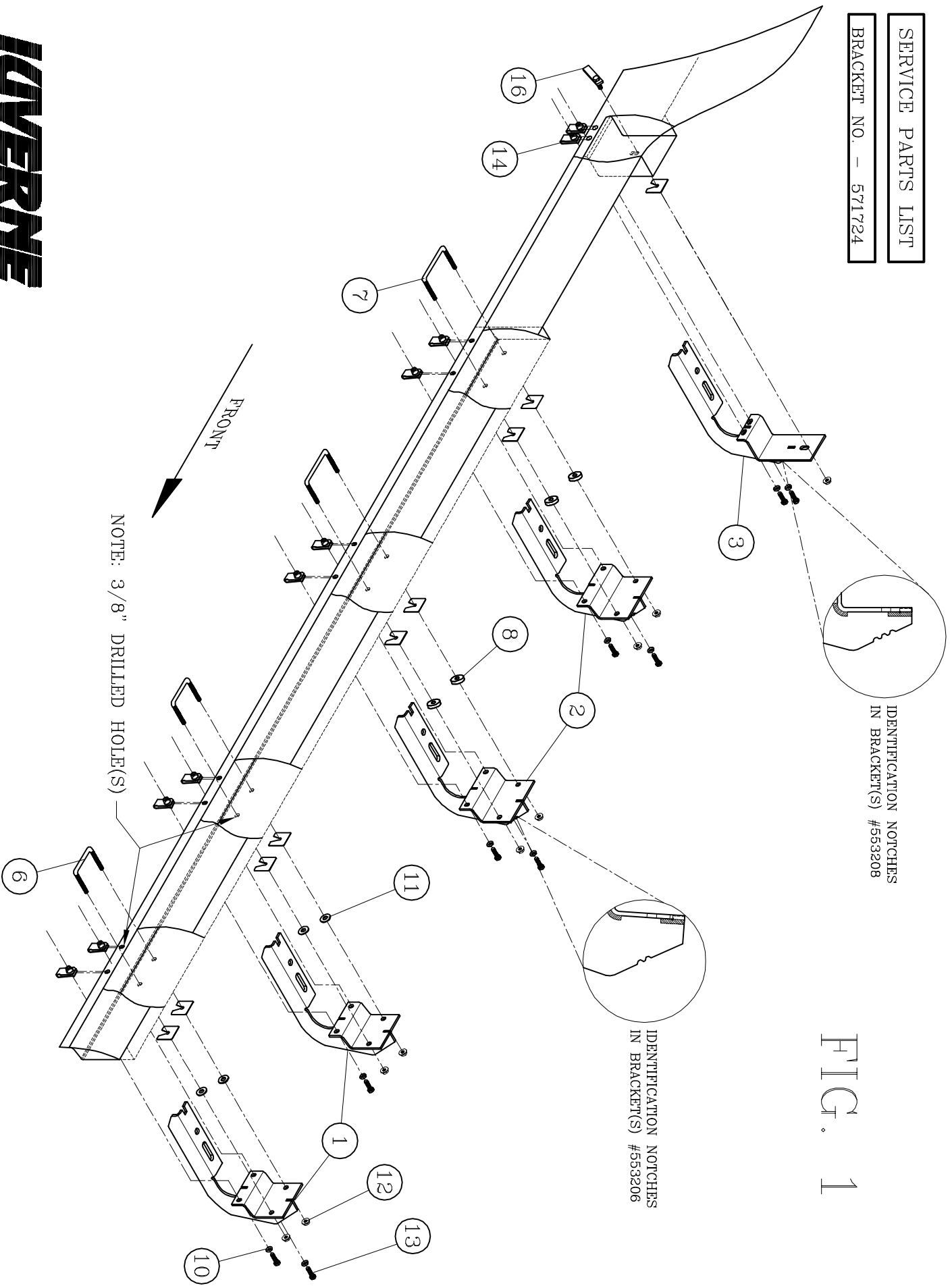

NOTE: 3/8" DRILLED HOLE(S)

FRONT

-RIGHT (PASSENGER) SIDE SHOWN-



SERVICE PARTS LIST

BRACKET NO. - 571724

IDENTIFICATION NOTCHES  
IN BRACKET(S) #553208

IDENTIFICATION NOTCHES  
IN BRACKET(S) #553206

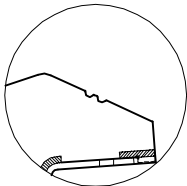
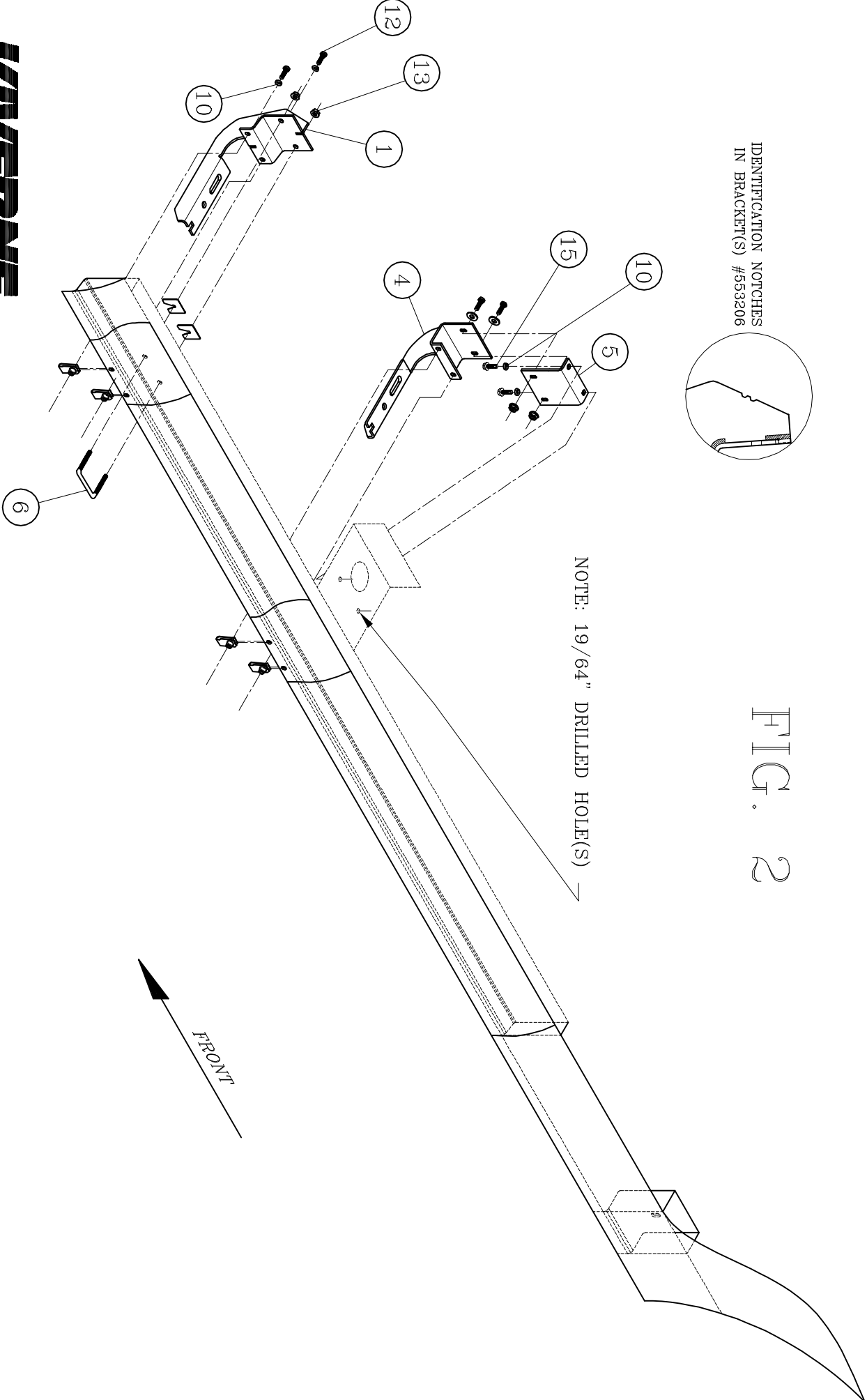

FIG. 2

NOTE: 19/64" DRILLED HOLE(S)



-LEFT (DRIVER) SIDE OPPOSITE-

# FIG. 3

-RIGHT (PASSENGER) SIDE SHOWN-

NOTE:  
THESE DIMENSIONS MAY NEED TO BE ADJUSTED FORWARD, OR BACKWARD  
TO AVOID DRILLING THROUGH SPOT WELDS IN THE PINCH SEAM.

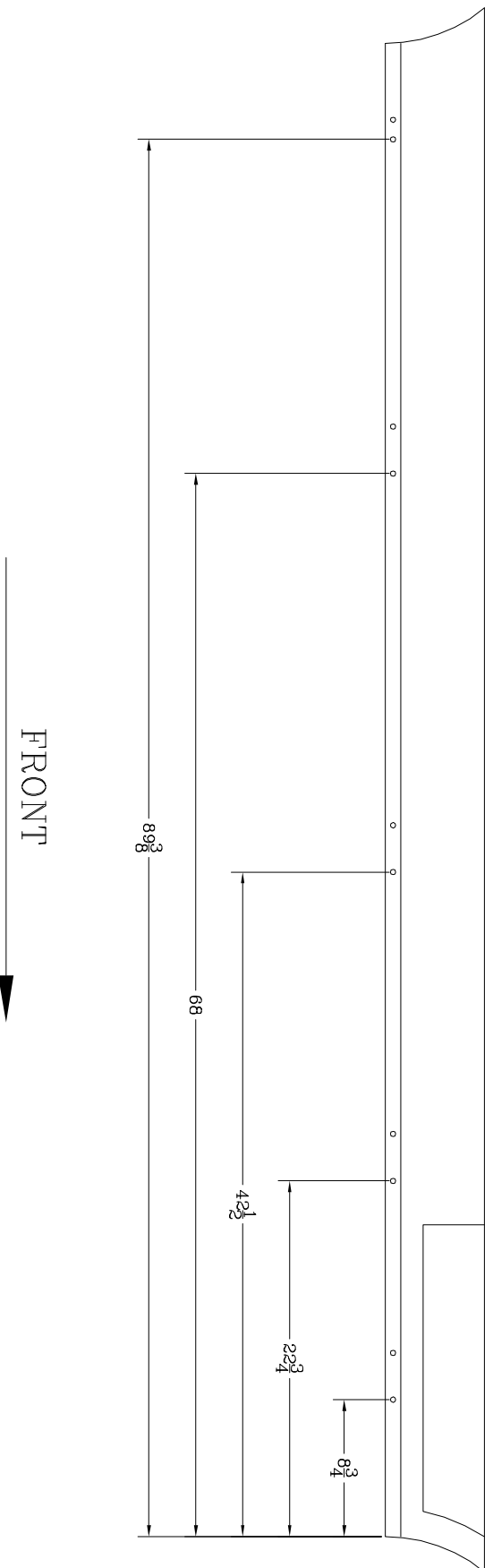



SERVICE PARTS LIST

BRACKET NO. - 571724

FIG. 4

-LEFT (DRIVERS) SIDE SHOWN-

NOTE:  
THESE DIMENSIONS MAY NEED TO BE ADJUSTED FORWARD, OR BACKWARD  
TO AVOID DRILLING THROUGH SPOT WELDS IN THE PINCH SEAM.

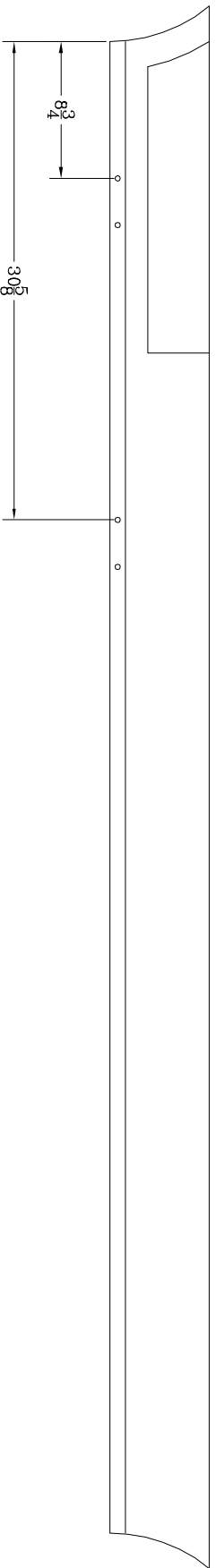

FRONT

