

Parts List

1	Driver / left side bar
1	Passenger / right side bar
1	Driver / left frame mounting bracket, front
1	Passenger / right frame mounting bracket, front
1	Driver / left frame mounting bracket, rear
1	Passenger / right frame mounting bracket, rear
1	Driver / left support bracket, front
1	Passenger / right support bracket, front
1	Driver / left mounting bracket, front
1	Passenger / right mounting bracket, front
1	Driver / left mounting bracket, rear
1	Passenger, right mounting bracket, rear
2	Tube spacer, 19mm x 95mm
14	Hex bolt, M10 - 1.50mm x 30mm
20	Flat washer, M10 x 20mm OD x 2mm
14	Lock washer, M10
6	Hex nut, M10
8	Hex bolt, M12 - 1.75mm x 40mm
2	Hex bolt, M12 - 1.75mm x 140mm
12	Flat washer, M12 x 24mm OD x 2.5mm
8	Flat washer, M12 x 32mm OD x 3mm
10	Lock washer, M12
10	Hex nut, M12

Level of Difficulty

Easy



Scan for helpful install tips

Product Image

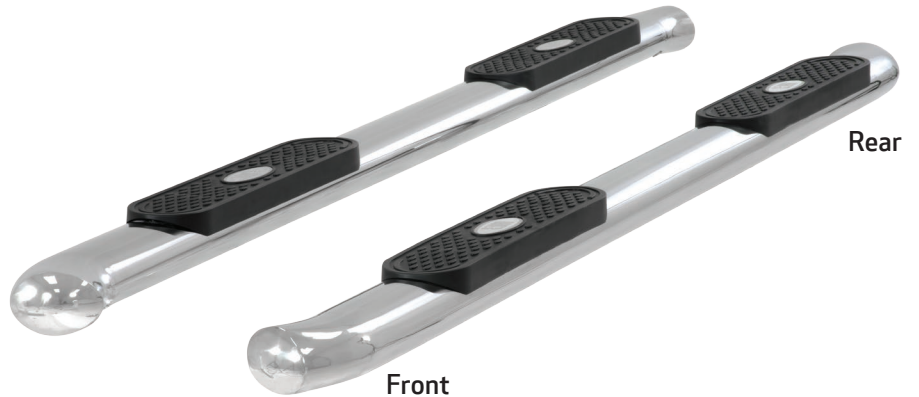

Notes and Maintenance

Before you begin installation, read all instructions thoroughly.

Proper tools will improve the quality of installation and reduce the time required.

To protect the product, wax after installing. Regular waxing is recommended to add a protective layer over the finish. Do not use any type of polish or wax that may contain abrasives that could damage the finish.

For stainless steel and aluminum, polish may be used to clear small scratches and scuffs on the finish. Mild soap may be used also to clean the product.

Refer to the table on page two when securing hardware during the installation process to help prevent damage to the product or vehicle.

Brackets and Hardware

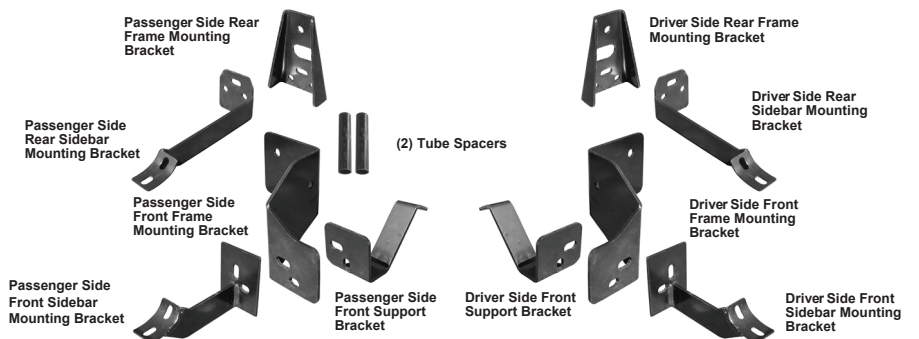

Torque Specifications

METRIC		SAE	
M6 bolt	3 ft.-lbs.	1/4" bolt	3 ft.-lbs.
M8 bolt	7 ft.-lbs.	5/16" bolt	7 ft.-lbs.
M10 bolt	16 ft.-lbs.	3/8" bolt	16 ft.-lbs.
M12 bolt	28 ft.-lbs.	7/16" bolt	20 ft.-lbs.
--	--	1/2" bolt	28 ft.-lbs.

PROCEDURE:

1. Start installation at the front, driver side of the vehicle. Locate the rectangular factory hole in the frame near the front body mount, **(Figure 1)**. Select the driver side front Frame Mounting Bracket and hold it up to the frame. Line up the hole in the Bracket with factory rectangular hole in the frame. Insert (1) 12mm x 140mm Hex Head Bolt with (1) 12mm Flat Washer through Mounting Bracket and frame, **(Figure 2)**. From the back of the frame, slide (1) Tube Spacer over the 12mm x 140mm Hex Bolt and push it into the frame, **(Figure 3)**. Slide (1) 12mm Flat Washer, (1) 12mm Lock Washer, and (1) 12mm Hex Nut, **(Figure 4)**. Snug but do not tighten at this time.
2. Locate the two holes in the bottom of the factory body mount bracket, **(Figure 1)**. Hang the driver side Front Support Bracket from the forward hole using the included (1) 10mm x 30mm Hex Bolt, (2) 10mm x 20mm OD x 2mm Flat Washers, (1) 10mm Lock Washer and (1) 10mm Hex Nut, **(Figure 5)**. Leave hardware loose at this time.
3. Select the driver side Front Sidebar Bracket and line up the mounting holes with the holes in the previously installed Frame Mounting Bracket and Support Bracket. Bolt the (3) Brackets together with (2) 12mm x 40mm Hex Bolts, (4) 12mm x 24mm Small Flat Washers, (2) 12mm Lock Washers and (2) 12mm Hex Nuts. Snug but do not tighten hardware at this time.
4. Move toward the rear mounting location, **(Figure 6)**, and bolt the driver side Rear Frame Mounting Bracket to the frame with the included (1) 12mm x 40mm Hex Bolt, (2) 12mm x 32mm OD x 3mm Large Flat Washers, (1) 12mm Lock Washer and (1) 12mm Hex Nut, **(Figure 7 & 8)**. Do not tighten hardware at this time.
5. Line up the (3) holes in the Frame Mounting Bracket with the holes in the driver side Rear Sidebar Bracket. Insert (1) 12mm x 40mm Hex Bolt with (1) 12mm x 24mm OD x 2.5mm Small Flat Washer through the top mounting hole with (1) 12mm x 24mm OD x 2.5mm Small Flat Washer, (1) 12mm Lock Washer and (1) 12mm Hex Nut securing it in place. Insert (2) 10mm x 30mm Hex Bolts, (4) 10mm Flat Washers, (2) 10mm Lock Washers and (2) 10mm Hex Nuts through the (2) remaining mounting holes. Snug but do not tighten hardware at this time.
6. Carefully place the driver side Sidebar onto the Mounting Brackets and line up the threaded inserts with the slots in the brackets. Secure the Sidebar to the Brackets with (4) 10mm x 30mm Hex Bolts, (4) 10mm Flat Washers and (4) 10mm Lock Washers. Snug but do not tighten hardware at this time.
7. Level and adjust Sidebar properly and tighten all hardware.
8. Repeat steps 1 – 7 for passenger Sidebar installation.
9. Do periodic inspections to the installation to make sure that all hardware is secure and tight.

Driver Side Installation Pictured

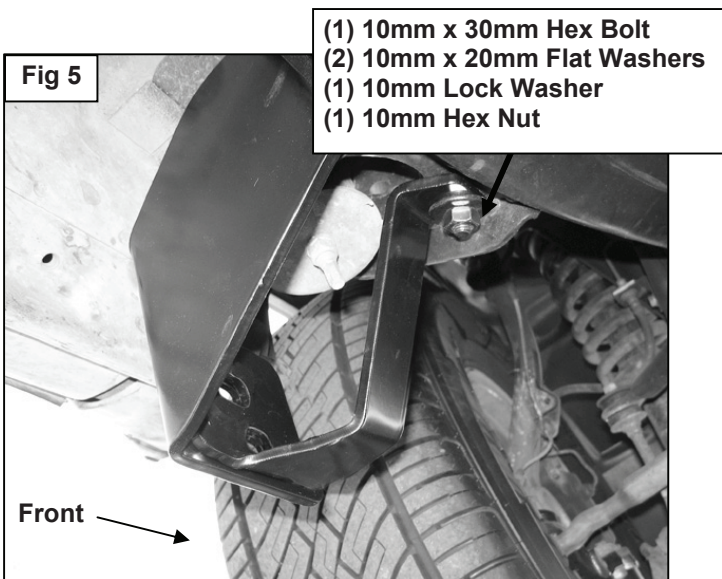
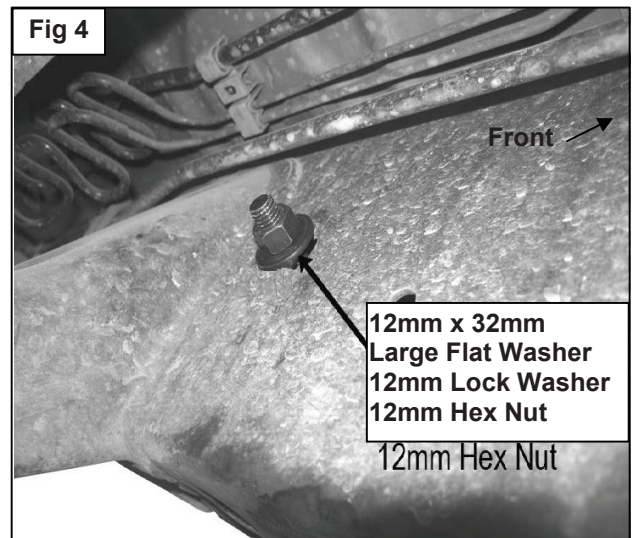
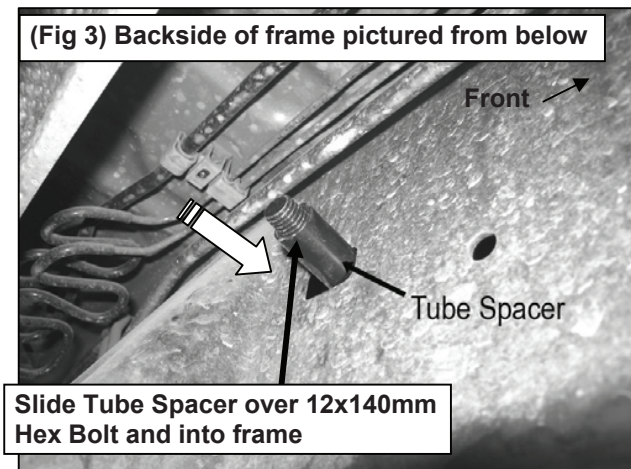
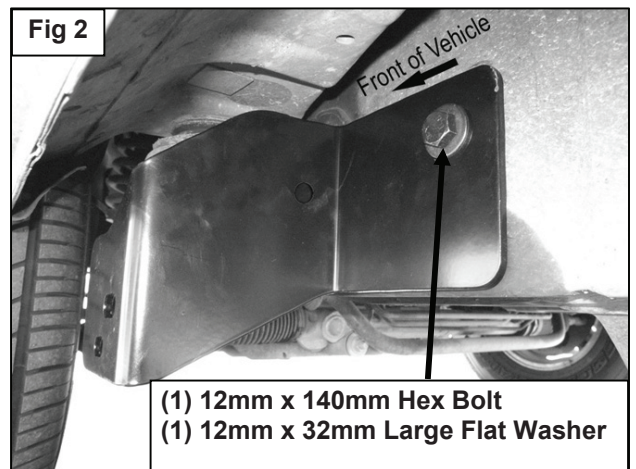
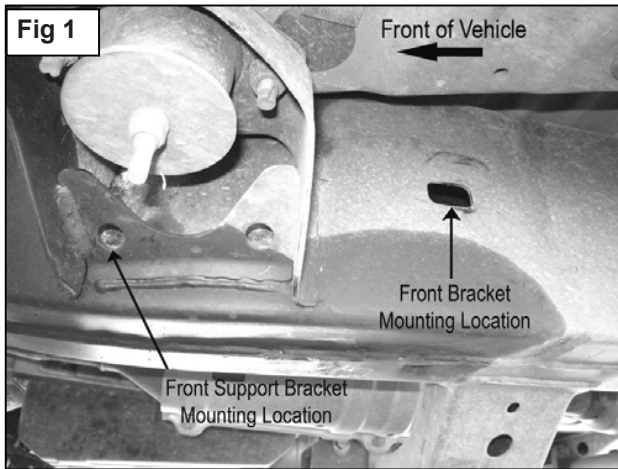

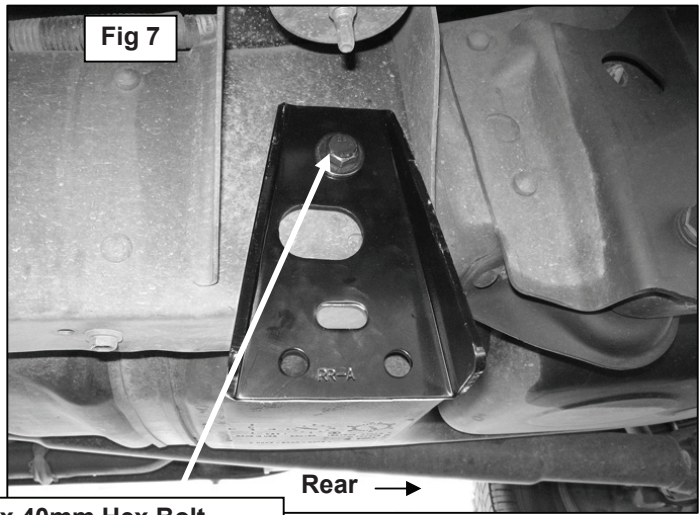
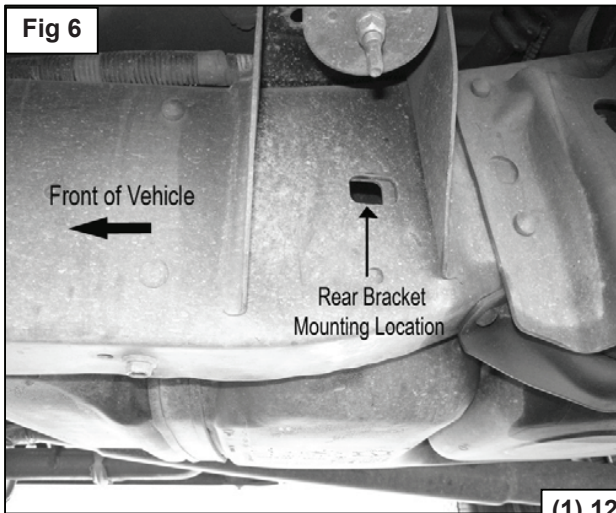

- (1) 12mm x 40mm Hex Bolt
- (2) 12mm x 32mm Flat Washers
- (1) 12mm Lock Washer
- (1) 12mm Hex Nut

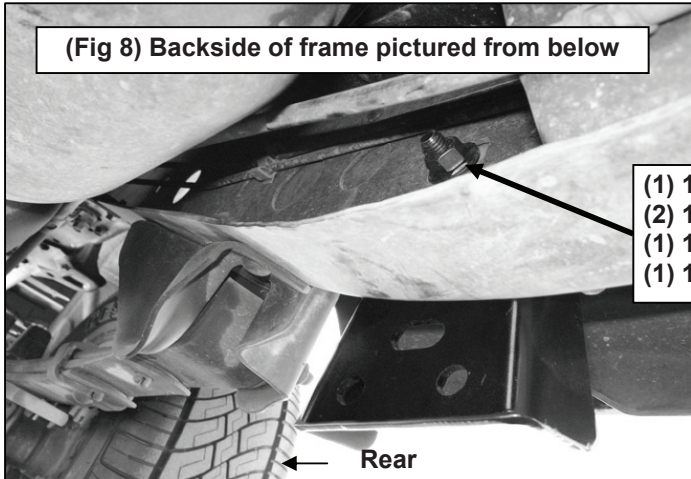

(Fig 8) Backside of frame pictured from below

- (1) 12mm x 40mm Hex Bolt
- (2) 12mm x 32mm Flat Washers
- (1) 12mm Lock Washer
- (1) 12mm Hex Nut

