

INSTALLATION INSTRUCTIONS

2014 SILVERADO 1500

PART # P4083

PARTS LIST:

Qty	Description	Qty	Description
1	Grille Guard Assembly	6	12-1.75mm Hex Nuts
2	Frame Brackets	4	10-1.50mm x 30mm Hex Bolts
1	Driver/Left Mounting Bracket	8	10mm x 27mm OD x 3mm Flat Washers
1	Passenger/Right Mounting Bracket	4	10mm Lock Washers
1	Driver/Left Top Bracket	4	10-1.50mm Hex Nuts
1	Passenger/Right Top Bracket	2	8-1.25mm x 25mm Button Head Allen Bolts
1	Driver/Left Top Inner Support Bracket	8	8-1.25mm x 30mm Hex Bolts
1	Passenger/Right Top Inner Support Bracket	12	8mm x 16mm OD x 1.6mm Flat Washers
2	Top Support Rear Backing Plates	8	8mm Lock Washers
2	12-1.75mm x 30mm Double Bolt Plates	2	8-1.25mm Nylon Lock Nuts
2	12-1.75mm x 35mm Single Bolt Plates	8	6-1.0mm x 25mm Hex Bolts
6	12mm x 24mm OD x 2.5mm Flat Washers	8	6mm x 18mm OD x 1.6mm Flat Washers
6	12mm Lock Washers	8	6mm Lock Washers
1	Support Flange	2	8mm Nut Clips

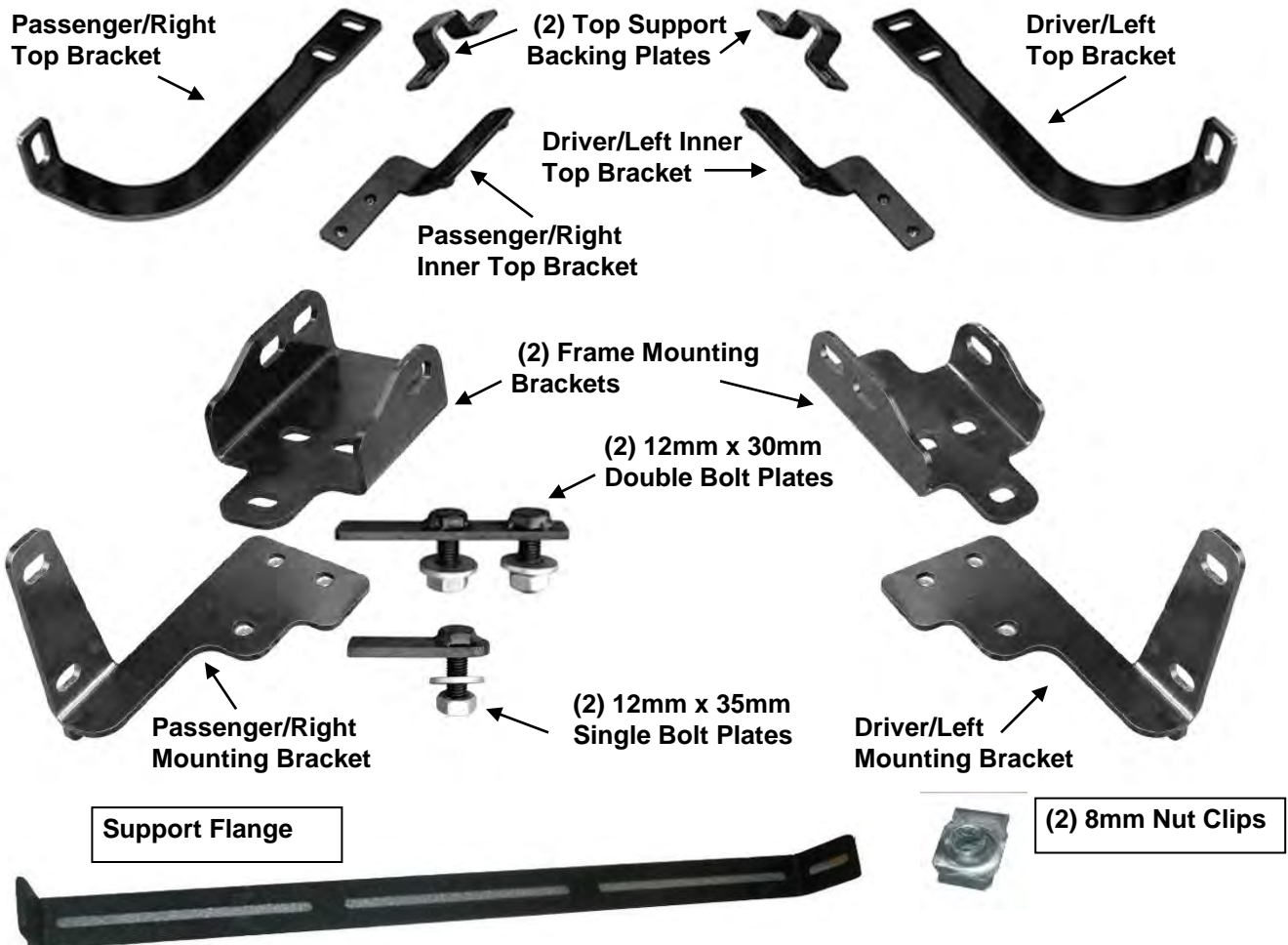

PROCEDURE:

1. REMOVE CONTENTS FROM BOX AND VERIFY ALL PARTS ARE PRESENT. READ INSTRUCTIONS CAREFULLY. DO NOT ATTEMPT INSTALLATION ALONE; PERSONAL INJURY OR DAMAGE TO THE VEHICLE MAY RESULT. CUTTING MAY BE REQUIRED. ASSISTANCE IS HIGHLY RECOMMENDED.
2. Start by Selecting your LED light (**Sold Separately**) mounting hardware & brackets, you will need to first attached the hardware to the support flange, (Example of LED light attached Fig 1) **NOTE: if you have your own LED light, LED Manufactures will have similar but different mounting styles or brackets, once you determine you mounting options attach it to the support flange as seen in (Fig1)**
3. With the LED light attached to the support flange select the (2) 8mm nut clips place each nut clip into the slotted holes on either side of the support flange, as seen in (**Fig 2**) with the support flange prepare you will need to lay the grill guard face down to install the support flange **NOTE:** (it is recommended to lay out some of the cardboard your grill guard came in or a blanket to protect the grill guard finish). place the grill guard face down with this done place the support flange with the LED attached into the Center flange attach each side of the support flange to the inner brackets inside the center flange of the grill guard with (2) 8mm hex bolts, (2) 8mm flat washers, & (2) 8mm lock washers as seen in (**Fig 3**) Snug but do not tighten at this time.
4. Start installation from under the front of the vehicle. Determine if the vehicle is equipped with tow hooks.

Tow Hook equipped vehicles:

- a. Remove the factory tow hook from the end of each frame channel, (**Fig 4**). **NOTE:** The driver side tow hook removal and the reinstallation of both tow hooks with the Grille Guard is difficult and assistance is highly recommended.
 - i. **Option 1:** Remove the hex bolts securing the driver side of the bumper to the bracket. Use a short pry bar or large screwdriver to move the tab on the bumper bracket up and away to clear the hex bolt and slide it out past the bumper bracket, (**Figs 5A, 5B & 8**).
 - ii. **Option 2:** Remove plastic radiator grille. Loosen and/or completely remove the front bumper to remove the long hex bolt in the driver side tow hook, (**Fig 5B**).
- b. Reattach the bumper after the tow hooks have been removed and the openings have been checked for Bracket clearance, (**Fig 8**). Leave factory hardware loose at this time.
- c. Next, select (1) Frame Bracket and the driver side Mounting Bracket, (**Fig 12**). Bolt the Mounting Bracket to the bottom of the Frame Bracket with (3) 8mm x 30mm Hex Bolts, (3) 8mm Lock Washers and (3) 8mm Flat Washers. Snug but do not fully tighten hardware at this time.
- d. Insert the Bracket assembly through the opening in the plastic bumper, (**Fig 8**). Line up the (3) holes in the Frame Bracket with the holes in the end of the frame channel.
- e. Insert the driver side tow hook back into position in the end of the frame above the Bracket Assembly, (**Fig 13**). Reattach the tow hook using only the long factory hex bolt inserted through the Frame Bracket and tow hook at this time. If tow hooks are not going to be reinstalled, skip ahead to **Step i, "Vehicles without tow hooks"** installation instructions.
- f. Leave hardware loose at this time.
- g. Repeat this **Steps c - f** to install the passenger side Bracket assembly and tow hook. Once both Bracket assemblies are installed, skip forward to **Step 3**.

Vehicles without tow hooks:

- a. Cut out the indented area in both sides of the plastic bumper insert to clear the Brackets as pictured, **(Figs 6 & 7)**. **IMPORTANT:** Make several small cuts for best fit. Do not cut through the top edge of the panel. **NOTE:** The plastic panel is held in place with several small screws. The screws at the top corners are difficult to impossible to reach and remove without damaging the cover with the bumper in place. If you prefer to remove the panel to cut out the openings, it may be necessary or easier to remove the plastic grille then the steel bumper assembly with the plastic panel attached to access all of the small screws and clips.
 - b. Reattach the bumper and/or bumper insert, (if removed), and grille once openings have been cut out and checked for clearance, **(Fig 8)**. Tighten all factory bumper hardware at this time.
 - h. Select (1) Frame Bracket, **(Fig 9)**. Insert the Bracket through the opening in the plastic bumper, **(Fig 8)**. Line up the (3) holes in the Bracket with the holes in the end of the frame channel.
 - i. Select (1) 12mm Double Bolt Plate, **(Fig 10A)**. Insert the Bolt Plate into the end of the frame channel, through the (2) holes in the side of the frame and out through the Bracket. Secure the Bolt Plate to the Bracket with (2) 12mm Flat Washers, (2) 12mm Lock Washers and (2) 12mm Hex Nuts, **(Fig 10B)**. Snug but do not fully tighten hardware at this time. Repeat this **Step** to install the 12mm x 35mm Single Bolt Plate, **(Fig 11A)**, into the remaining hole in the other side of the frame channel and Bracket, **(Figs 11B & 11C)**.
 - j. Next, select the driver side Mounting Bracket. Bolt the Mounting Bracket to the bottom of the Frame Bracket with (3) 8mm x 30mm Hex Bolts, (3) 8mm Lock Washers and (3) 8mm Flat Washers, **(Figs 12 & 13)**. Do not tighten hardware at this time.
 - k. Repeat **Steps h - j** to install the passenger side Frame and Mounting Brackets.
5. With assistance, hold the Grille Guard up in position on the outside of the Mounting Brackets. Bolt the Grille Guard to the Brackets with (4) 10mm x 30mm Hex Bolts, (8) 10mm Flat Washers, (4) 10mm Lock Washers and (4) 10mm Hex Nuts, **(Fig 13)**. Snug but do not tighten hardware at this time.
 6. Check the Grille guard side to side alignment with the vehicle. Adjust as required then tighten only the (6) 8mm Hex Bolts securing the Mounting Brackets to the bottom of the Frame Brackets.
 - a. **Vehicles with tow hooks:** Once adjusted side to side and after the 8mm hardware is tightened, insert the short factory tow hook bolt, (one per tow hook), through the remaining hole in the Frame Bracket and back into the tow hook. Repeat to reinstall the passenger side tow hook bolt.
 7. Tighten all tow hook and/or Frame Mounting Bracket hardware at this time. Do not fully tighten the Grille Guard to Bracket hardware at this time.
 8. Next, open the hood and remove the plastic cover between the top of the grille and the radiator, **(Fig 14)**. **NOTE:** Use a small flat head screw driver to pop up the center of the plastic clips.
 9. Locate the square tube support braces running up at an angle from the top of the frame channel to the bottom of the hood release mechanism, **(Figs 15B, 17 & 18)**. Select the driver side Inner Top Bracket and (1) Backing Plate, **(Fig 15A)**. Hold the Inner Bracket up to the bottom of the brace tube with the Backing Plate over the top. Bolt the Brackets together around the square tube with (2) 6mm x 25mm Hex Bolts, (2) 6mm Lock Washers and (2) 6mm Flat Washers, **(Fig 15B)**. Leave loose at this time.
 10. Repeat **Step 9** for passenger side Inner Top Bracket and (1) Backing Plate, **(Figs 15A & 15B)**.
 11. Select the driver side Outer Top Bracket, **(Fig 16)**. Insert the Outer Bracket through the grille and up to the Inner Top Bracket assembly, **(Figs 17 & 18)**. Slide the Bracket assembly up or down the tube to match up with the Outer Top Bracket. Bolt the Outer Bracket to the top of the Inner Bracket with (2) 6mm x 25mm Hex Bolts, (2) 6mm Lock Washers and (2) 6mm Flat Washers. Leave hardware loose at this time.

12. Line up the outer bent end of the Top Bracket with the hole in the Grille Guard upright. Bolt the bent end of the Outer Top Bracket to the upright with (1) 10mm x 25mm Button Head Allen Bolt, (2) 10mm Flat Washers and (1) 10mm Nylon Lock Nut, **(Fig 19)**.
13. Repeat **Steps 8 – 12** for passenger side Top Bracket assembly installation.
14. Level and adjust the Grille Guard and fully tighten all hardware including bumper, bumper bracket and all Grille Guard Bracket hardware. **IMPORTANT:** Adjust the position of the Top Brackets so that they cannot come in contact with the plastic grille, **(Fig 19)**.
15. Reinstall the top plastic cover using the factory hardware.
16. Do periodic inspections to the installation to make sure that all hardware is secure and tight.

To protect your investment, wax this product after installing. Regular waxing is recommended to add a protective layer over the finish. Do not use any type of polish or wax that may contain abrasives that could damage the finish.

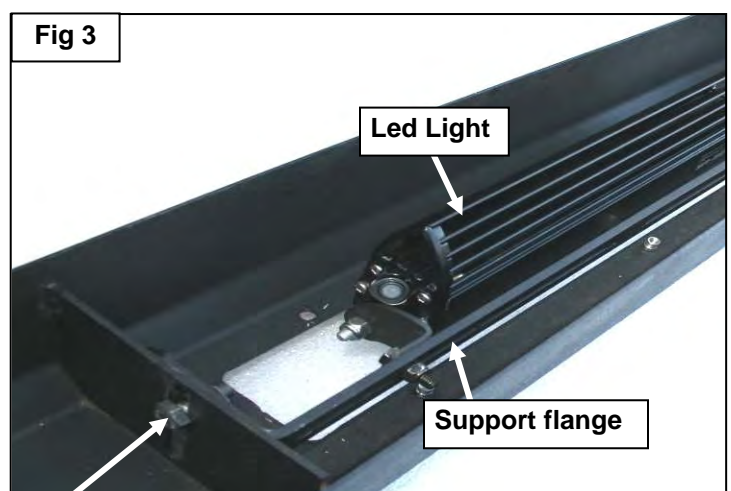
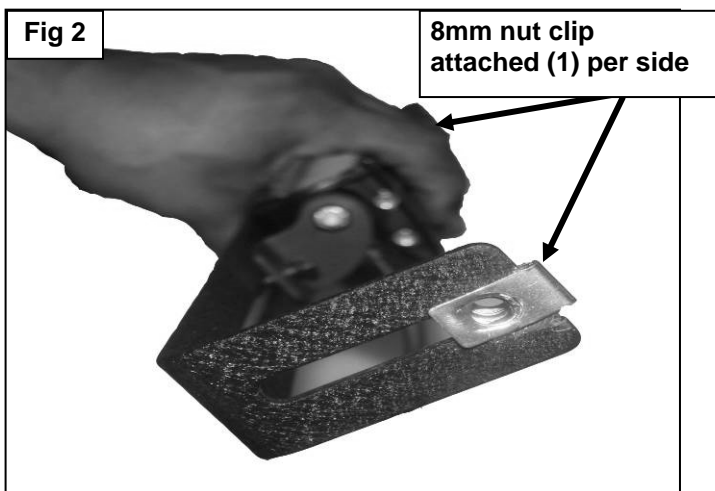
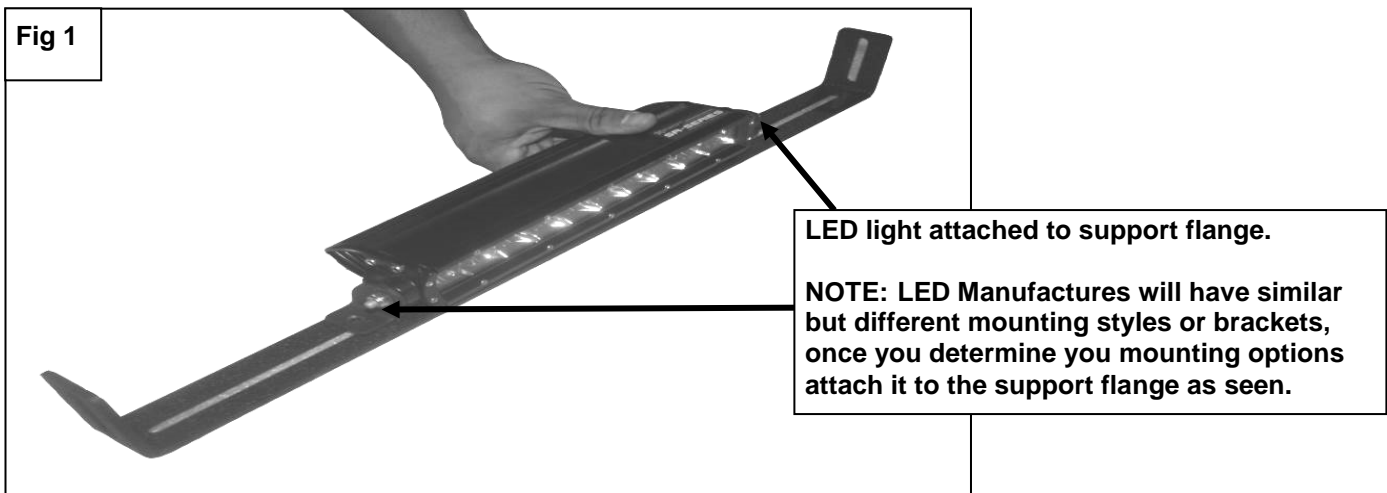

Secure support flange into center flange with
 (1) 8mm Hex head bolt
 (1) 8mm Flat Washers
 (1) 8mm Lock washer
 Per side.

Driver Side Mounting Bracket Installation Pictured



(Fig 4) Opening for tow hook pictured

Remove the bolts securing the driver side of the bumper to the bumper bracket. Use a large screwdriver or pry bar to move the mounting tab up enough to get the long bolt through the tow hook out of the end of the frame

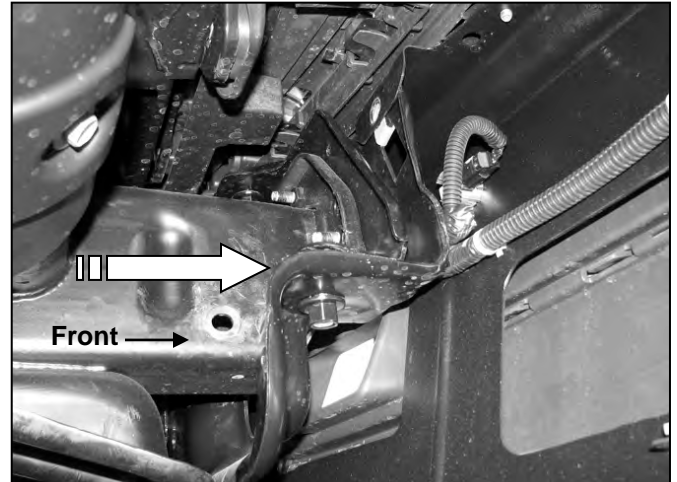

(Fig 5A) Driver side pictured from behind bumper

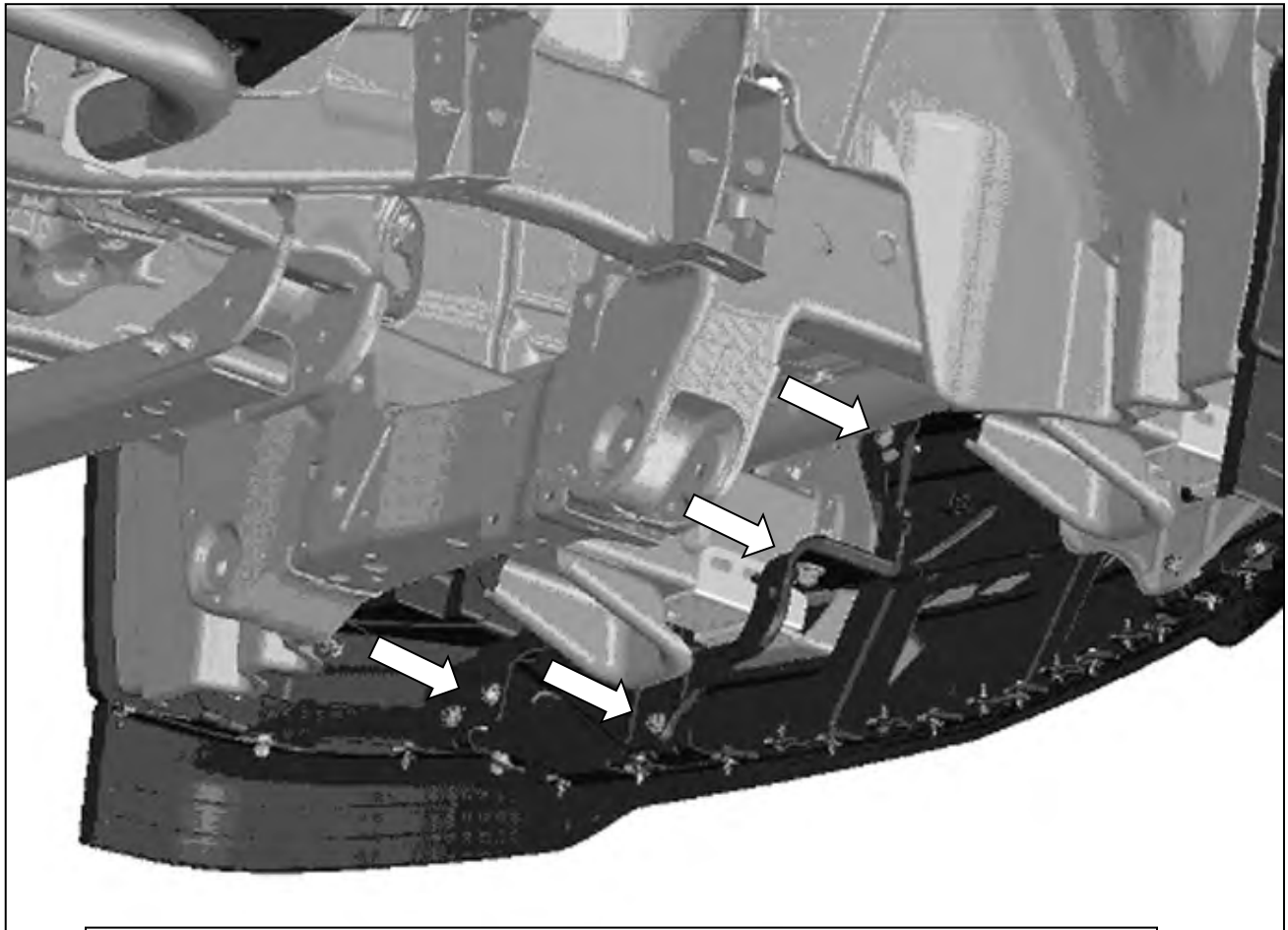

(Fig 5B) Driver side illustrated from behind bumper to show bumper bolt locations



(Fig 6) "No tow hook" model pictured

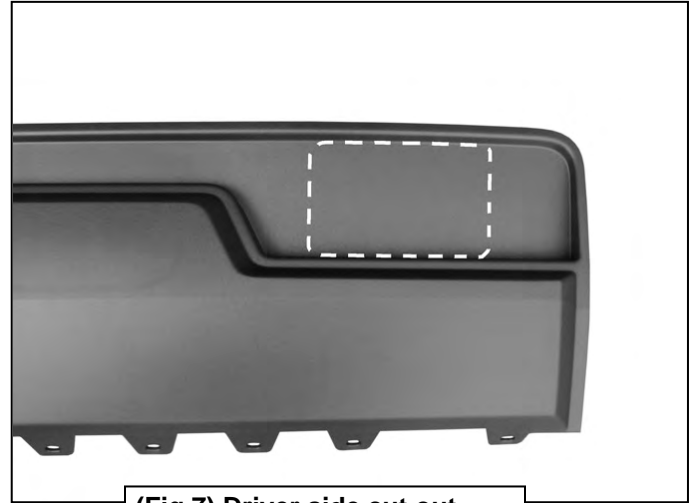

(Fig 7) Driver side cut out illustrated for reference only

Driver Side Mounting Bracket Installation Pictured

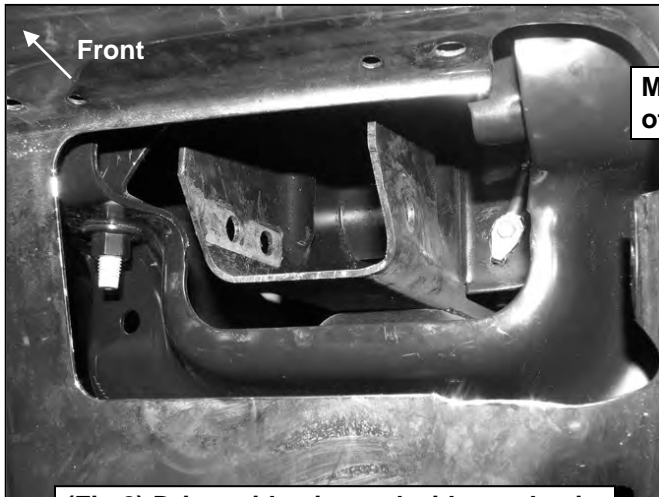

Mounting holes in end of frame for tow hook

(Fig 8) Driver side pictured without plastic panel for instruction purposes only

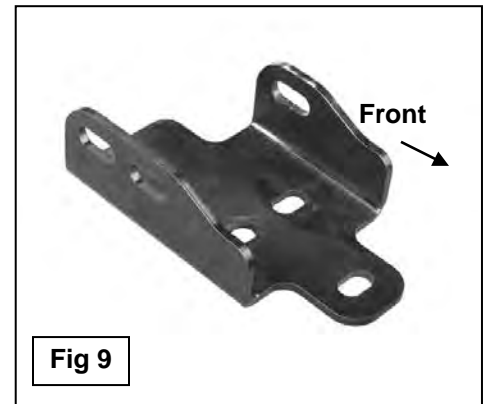

Fig 9

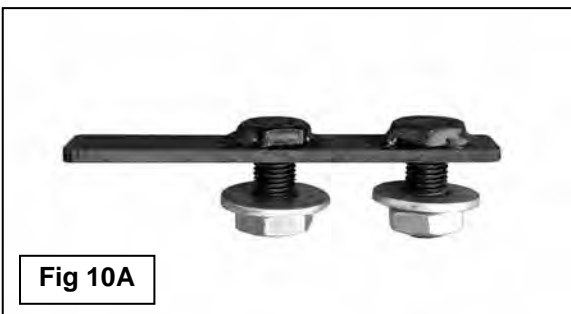

Fig 10A

- 12mm Double Bolt Plate
- (2) 12mm Flat Washers
- (2) 12mm Lock Washers
- (2) 12mm Hex Nuts

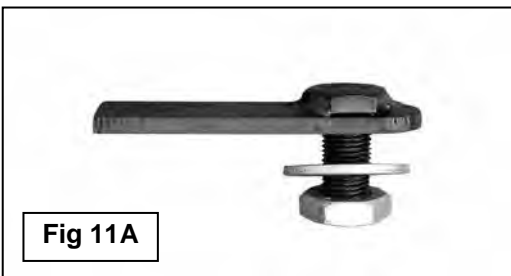

Fig 11A

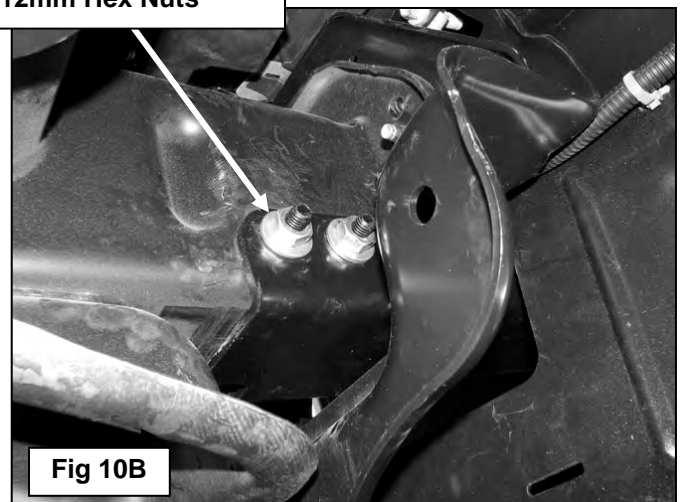
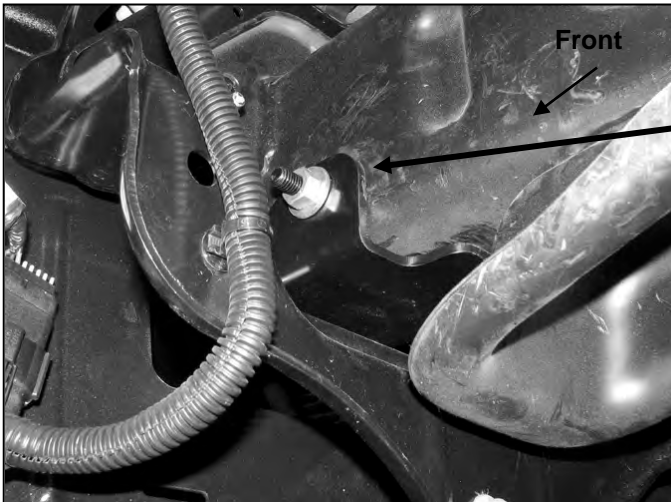

Fig 10B

Driver Side Installation Pictured



12mm Bolt Plate
12mm Flat Washer
12mm Lock Washer
12mm Hex Nut

(Fig 11B) Driver side Bracket installation pictured

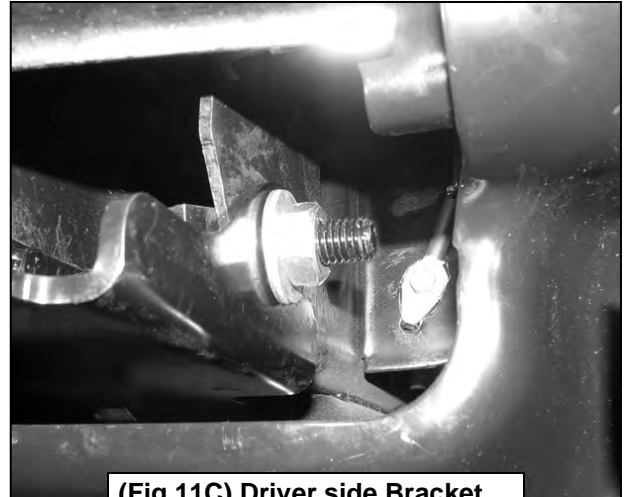

(Fig 11C) Driver side Bracket installation pictured from front

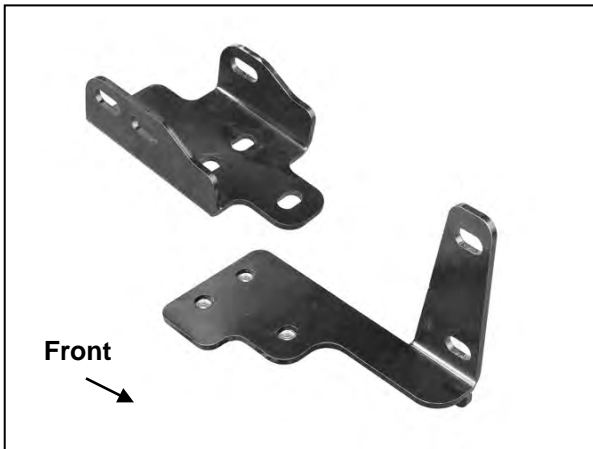

(Fig 12) Driver side Mounting Brackets pictured

Bolt the Mounting Bracket to the bottom of the Frame Bracket with:
(3) 8mm 30mm Hex Bolts
(3) 8mm Lock Washers
(3) 8mm Flat Washers

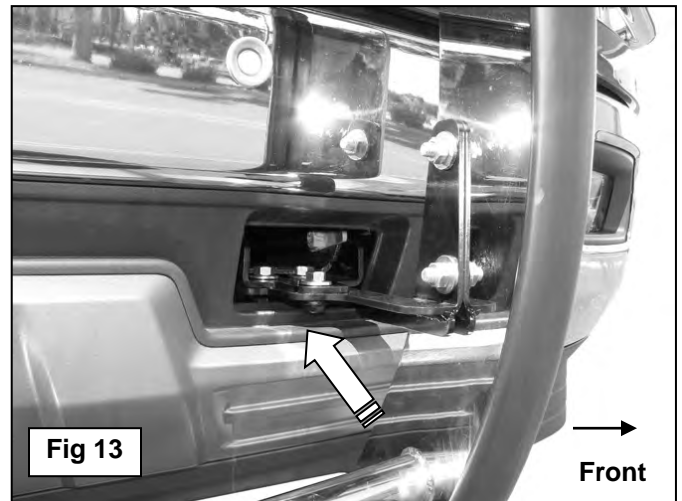
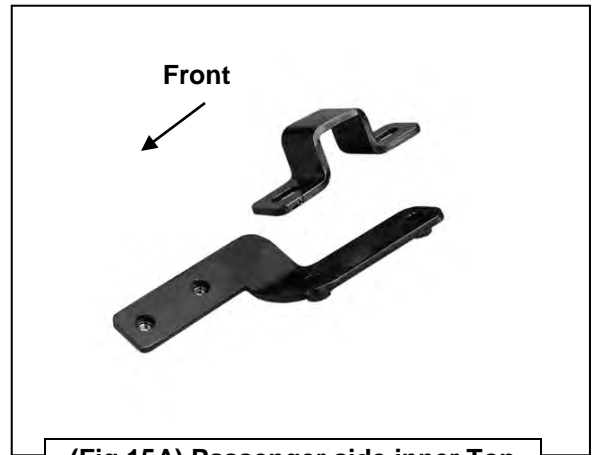

Fig 13



(Fig 14) Remove plastic cover on top of grille



(Fig 15A) Passenger side inner Top Bracket and Backing Plate pictured

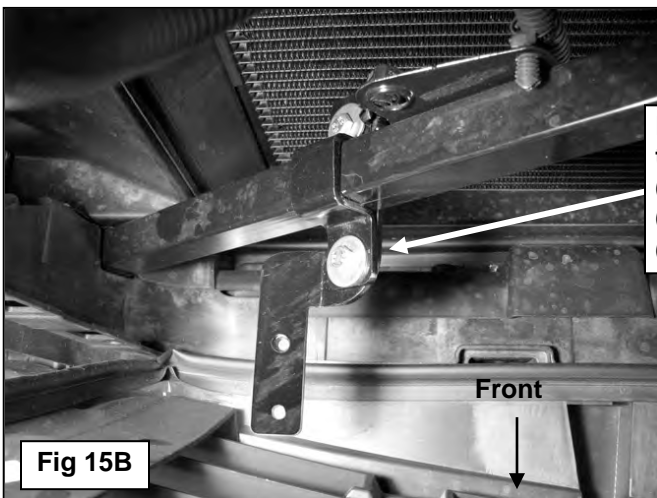
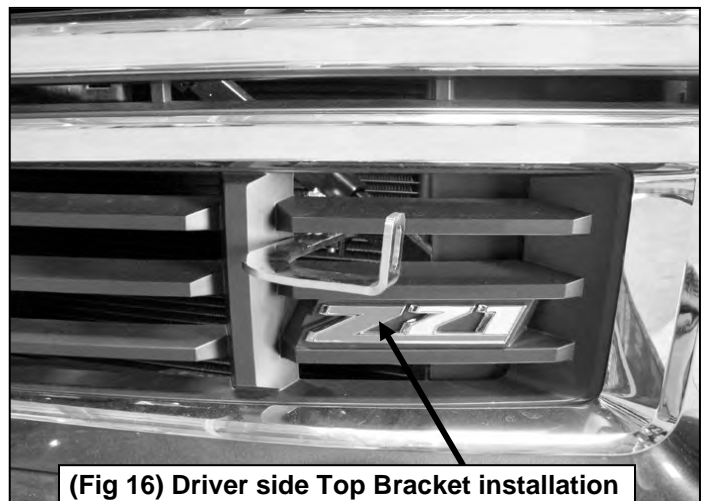
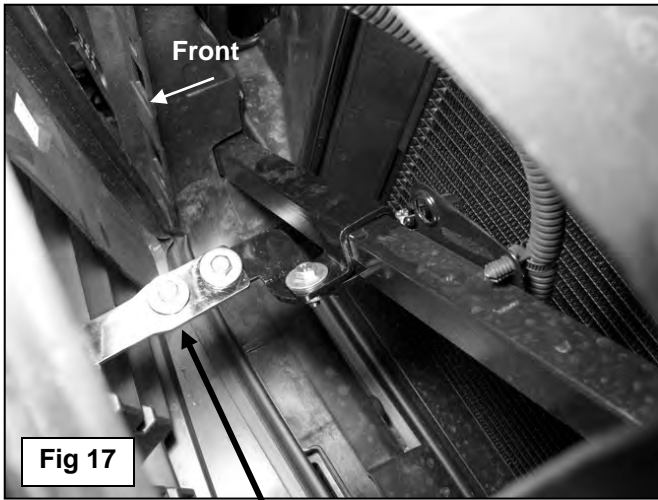

Fig 15B

Bolt the Top Inner Bracket to the Backing Plate with:
(2) 6mm x 25mm Hex Bolts
(2) 6mm Lock Washers
(2) 6mm Flat Washers



(Fig 16) Driver side Top Bracket installation pictured. Adjust position so that Bracket cannot come in contact with plastic grille



Bolt the Top Outer Bracket to the Inner Bracket with:
 (2) 6mm x 25mm Hex Bolts
 (2) 6mm Lock Washers
 (2) 6mm Flat Washers

**6mm x 25mm Hex Bolts
 6mm Lock Washers
 6mm Flat Washers**

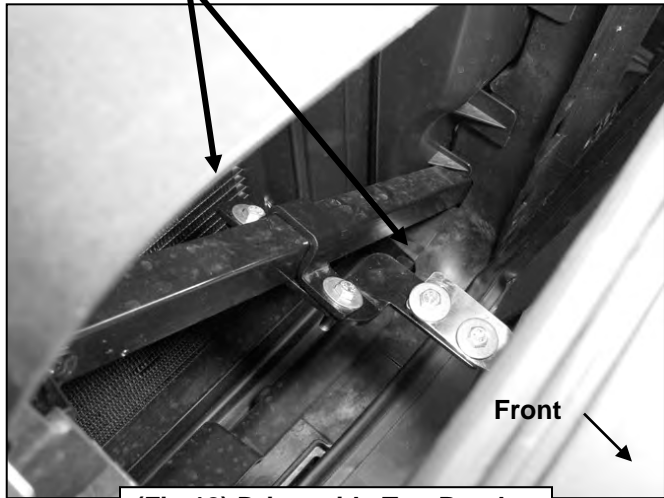

(Fig 18) Driver side Top Bracket installation pictured

**(1) 8mm Button Head Bolt
 (2) 8mm Flat Washers
 (1) 8mm Nylon Lock Nut**

**6mm x 25mm Hex Bolts
 6mm Lock Washers
 6mm Flat Washers**

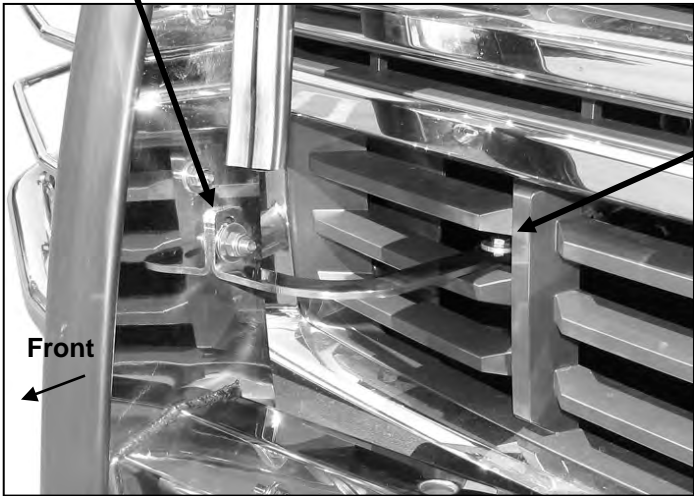

(Fig 19) Passenger side outer Top Bracket pictured