

# INSTALLATION INSTRUCTIONS

## GRILL/BRUSH GUARD

04-08 NISSAN TITAN INCLUDES PRO 4-X / 04-08 ARMADA

PART NUMBER 9046/9046-2

### PARTS LIST:

1	Grille Guard	4	12mm Nylock Nuts
1	Passenger Side Mounting Bracket	4	12mm ID x 29mm OD x 3mm Flat Washers
1	Driver Side Mounting Bracket	8	12mm ID x 24mm OD Flat Washers
1	Passenger Side Top Bracket for Titan and 04-07 Armada	2	10-1.50mm x 25mm Hex Bolts
1	Driver Side Top Bracket for Titan and 04-07 Armada	2	10mm Nylock Nuts
1	Passenger Side Top Bracket for 08 Armada	4	10mm Flat Washers
1	Driver Side Top Bracket for 08 Armada	2	8mm x 35mm Hex Head Bolts
4	12-1.25mm x 45mm Hex Bolts GD 10.5	2	8mm Nylock Nuts
4	12-1.25mm x 30mm Hex Bolts	4	8mm Flat Washers
		2	2" x 1 1/4" Adhesive Foam Strips

**Passenger Side  
Mounting Bracket**



**Driver Side  
Mounting Bracket**

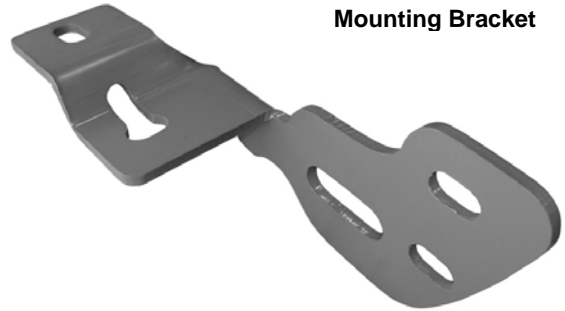

**Passenger Side  
Top Bracket  
08-On Armada**



**Driver Side Top  
Bracket  
08-On Armada**



**Passenger Side  
Top Bracket  
04-08 Titan /  
04-07 Armadas**



**Driver Side  
Top Bracket  
04-08 Titan /  
04-07 Armadas**



## PROCEDURE:

- 1. REMOVE CONTENTS FROM BOX. VERIFY ALL PARTS ARE PRESENT. READ INSTRUCTIONS CAREFULLY.**
- If vehicle is equipped with factory tow hooks, remove them from vehicle. Take the front bolt off the vehicle but only loosen the rear one by 3/8". Slide the tow hook to the rear to remove it, **(Figure 1)**.  
**Note: On Titan PRO 4x**, first remove the skid plate to get to the tow hooks. In the front remove the four Torx bolts and in the rear, the two hex bolts holding the factory skid plate, **(Figure 2&3)**. Next remove skid plate from vehicle and set aside, then remove the skid plate mounting bracket and tow hook from truck.
- Once the tow hooks are removed, proceed to install the Mounting Brackets. Locate driver side Mounting Bracket and position it onto frame. Place driver side tow hook on top of Mounting Bracket, **(PRO 4X also replace the skid plate mounting bracket)** and re-attach it to the frame by using the factory tow hook bolts, **(Figure 4&4b)**. **NOTE:** If vehicle is not equipped with factory tow hooks, use the included (2) 12-1.25mm x 40mm Hex Bolts "Grade 10.5" and (2) 12mm Oversize Flat Washers to attach Mounting Bracket to frame, **(Figure 5)**. Do not tighten at this time. Repeat this step for passenger side.
- On all Models:** Open the hood and remove the factory grille shell from the front of the vehicle. There are twelve clips holding the grille shell in place. Once clips are removed, carefully pull on grille shell to remove it, **(Figure 6)**. Set grille shell assembly in a clean area.
- Apply foam strips to the bottom and top surface of the Top Support Bracket to protect the finish of the bumper and grille shell, a must on the **08 Armada**, **(Figure 7a)**.
- 08 Armada:** There are two plastic fasteners on each side of the top inner side of the bumper. Remove the outer plastic fastener on each side, (the one closer to the lights). Attach driver side Top Support Bracket using the included (1) 8mm x 35mm Hex Head Bolt, (2) 8mm Flat Washers, and (1) 8mm Nylock Nut, **(Figure 7b)**. Do not tighten at this time. Repeat this step for passenger side.  
**All Titan & 07 back Armada:** Remove the two factory bolts located on the top inner side of the bumper. Attach Top Brackets using the existing bolts, **(Figure 8)**. Do not tighten at this time.
- Re-install the factory grille shell back onto the vehicle. **NOTE:** To ease the re-installation of the grille shell, mount the fasteners on the grille shell. Once all the fasteners are installed on the grille shell, align fasteners to the original mounting location and push them back into place, **(Figure 9)**.
- With help, position Grille Guard on the outer side of the Mounting Brackets. Attach Grille Guard to Mounting Brackets with the included (6) 12-1.75mm x 35mm Hex Bolts, (4) 12mm Nylock Nuts, and (8) 12mm Flat Washers, **(Figure 10)**. Do not tighten at this time.
- Proceed to attach Top Brackets to Grille Guard with the included (2) 10-1.5mm x 25mm Allen Bolts, (2) 10mm Nylock Nuts, and (4) 10mm Flat Washers, **(Figure 11)**. Do not tighten at this time.
- Level and adjust Grille Guard, then tighten all hardware at this time.
- For PRO 4X** and others with skid plates, reinstall the skid plate now reusing your factory hardware.
- Do periodic inspections to the installation to make sure that all hardware is secure and tight.

**To protect your investment**, wax this product after installing. Regular waxing is recommended to add a protective layer over the finish. Do not use any type of polish or wax that may contain abrasives that could damage the finish.

**For stainless steel:** Aluminum polish may be used to polish small scratches and scuffs on the finish. Mild soap may be used also to clean the Grille Guard.

For gloss black finishes: Mild soap may be used to clean the Grille Guard.

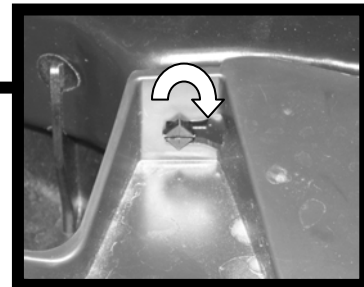
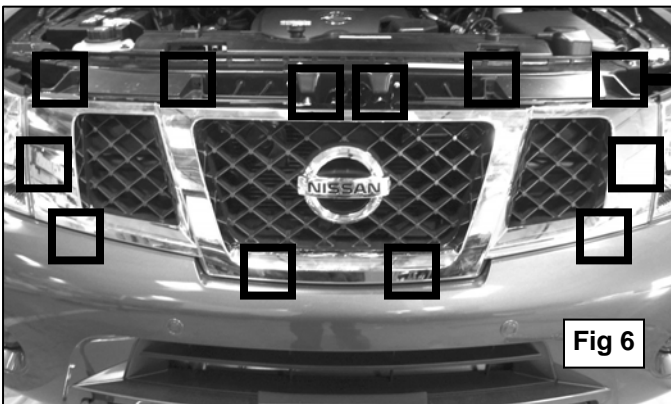
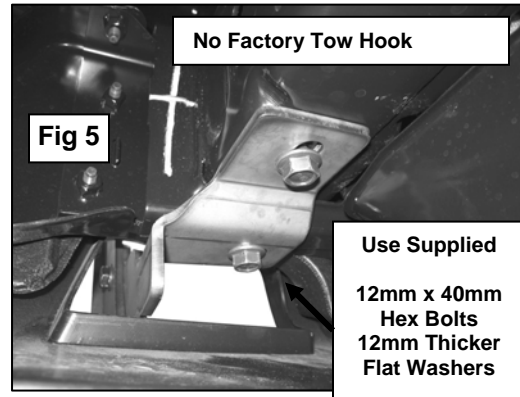
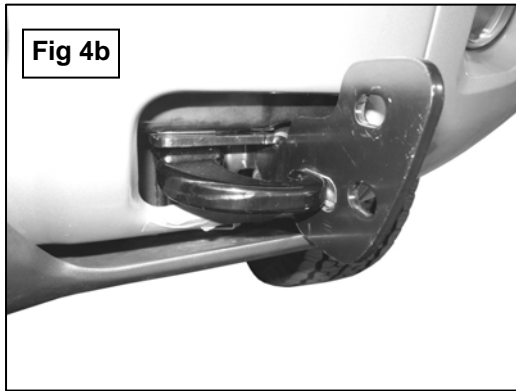
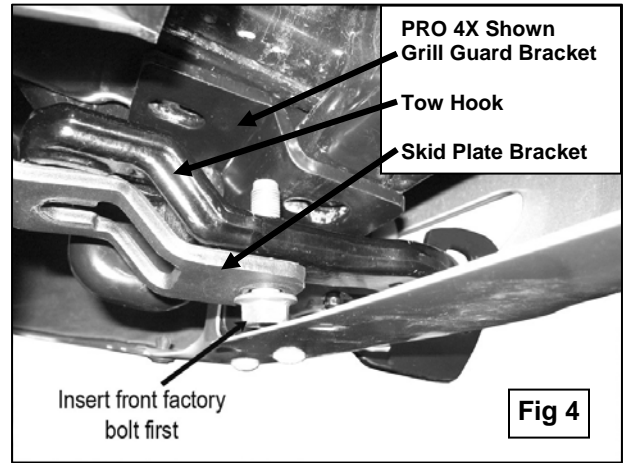
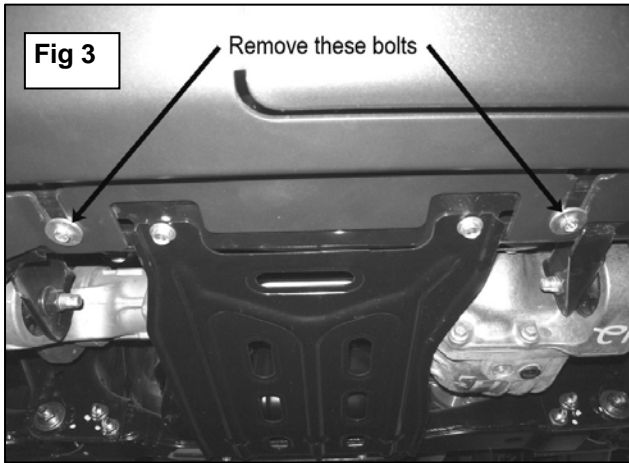
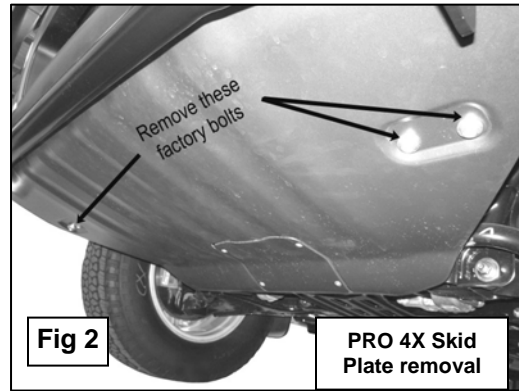
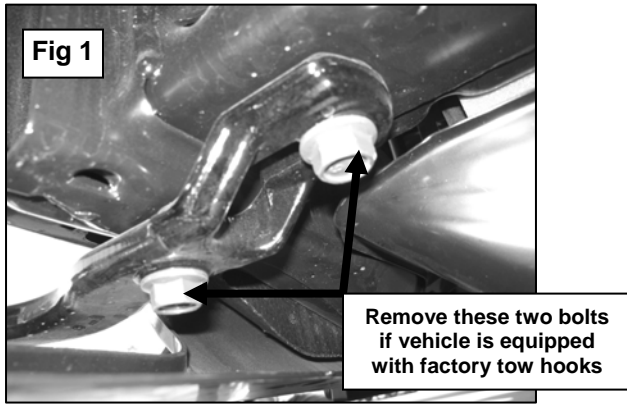

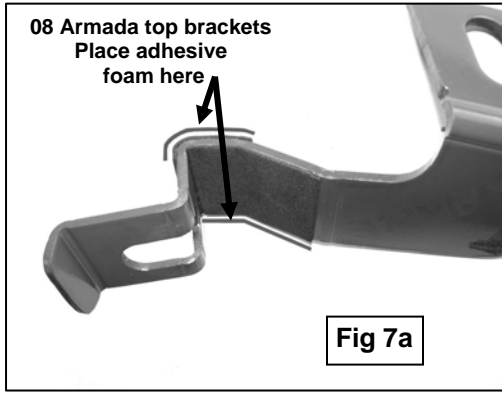

Fig 7a

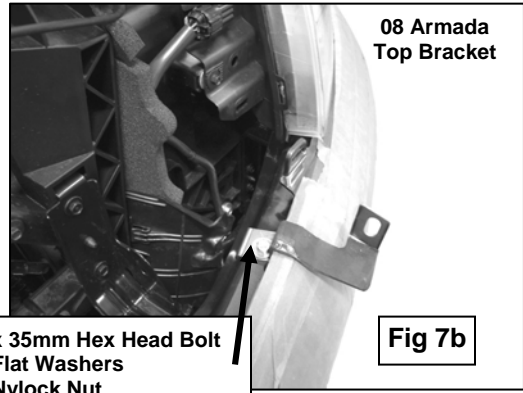

Fig 7b

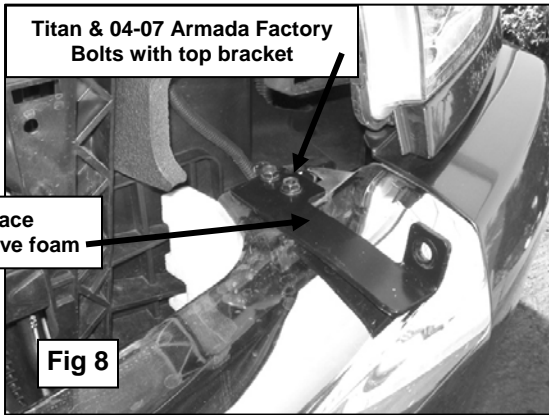

Fig 8

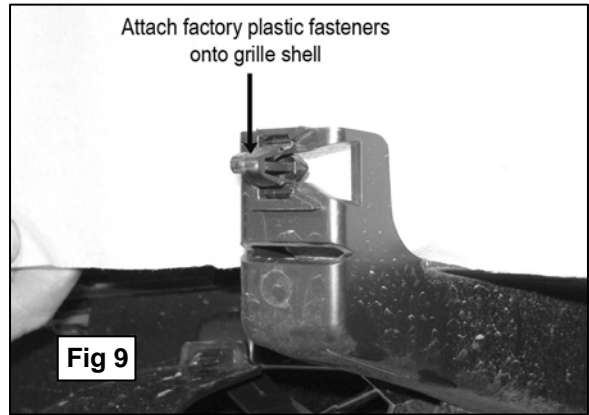

Fig 9

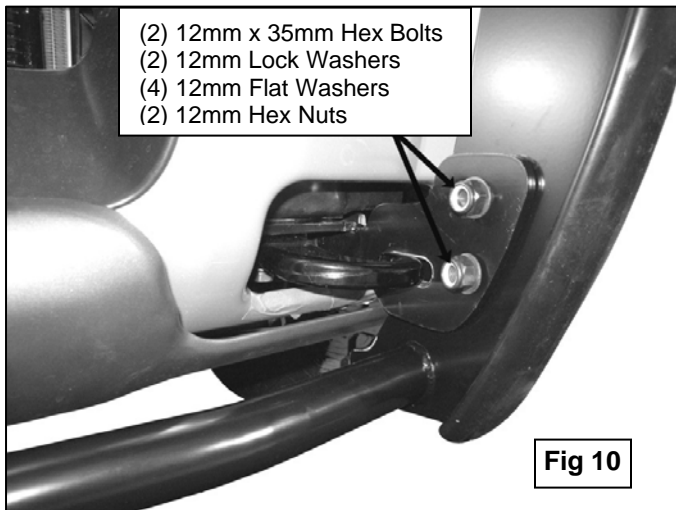

Fig 10

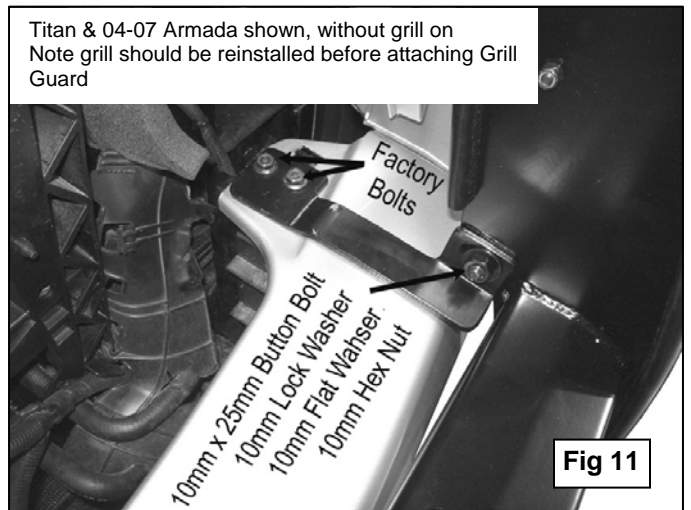

Fig 11

