

INSTALLATION INSTRUCTION

ITEM NO:4494











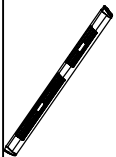

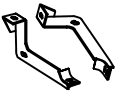
APPLICATION:For Chevy Silverado 1500 2500 3500 – Crew Cab 01-13

ATTENTION

1. Please read this installation instruction before installing this part.
When install it, please pay attention to protecting your vehicles.

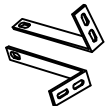
2. When you use it, please check this parts at a fix time-lapse, such as one month or two month.

PARTS LIST

No	Name	Photo	Qty	Remarks	No	Name	Photo	Qty	Remarks
A	Side bar		2	lateral symmetry	G	Flange Lock Nut		6	M10
B	front bracket		2	lateral symmetry	H	Hex Bolt		2	M10X30
C	middle bracket		2	lateral symmetry	I	flat washer		2	M10
D	rear bracket		2	lateral symmetry	J	"T"Bolt		6	
E	support bracket		2	lateral symmetry	K	flat washer		24	M6
F	"T" Bolt		2	M10X30	L	LOCK NUT		24	M6

INSTALLATION STEPS

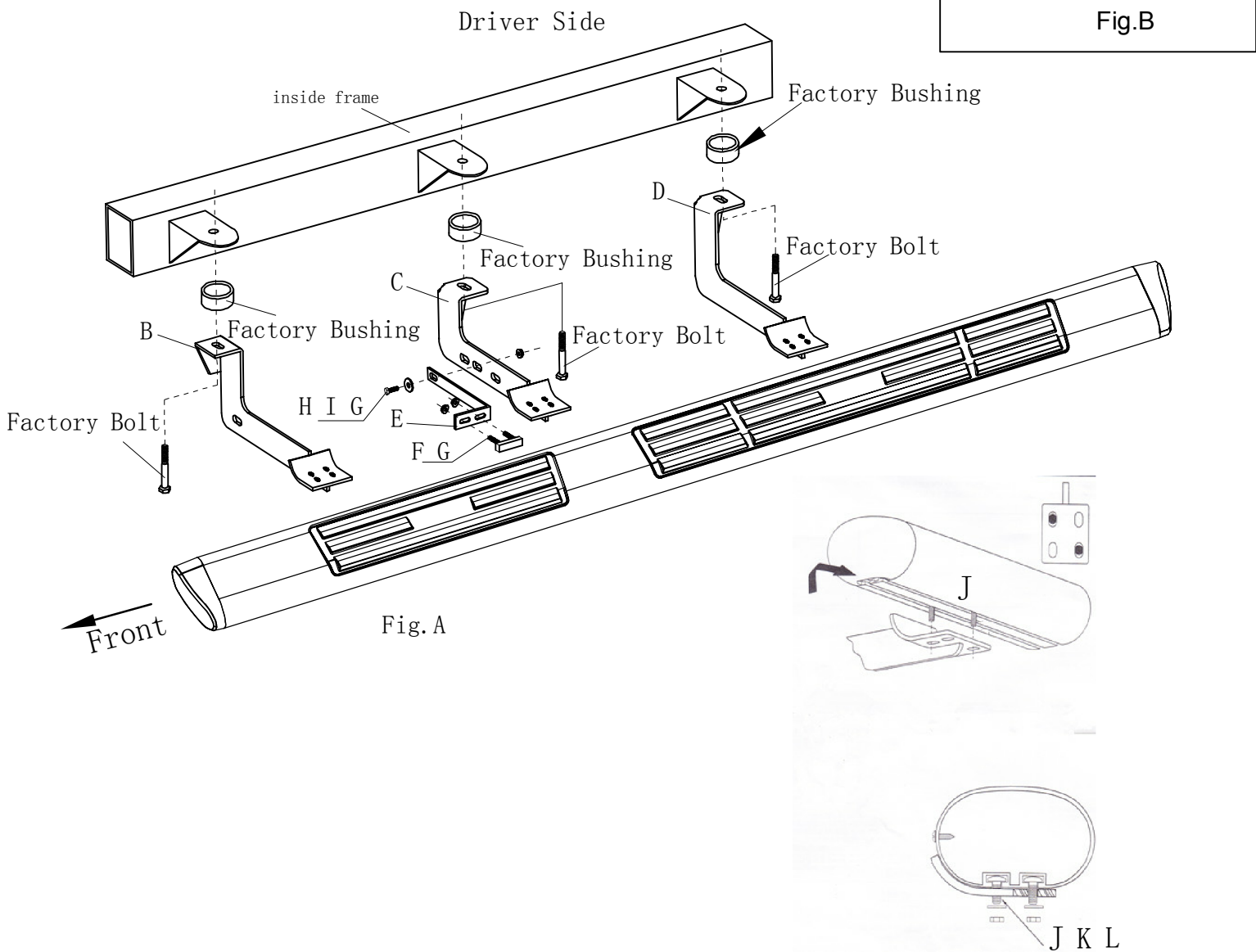

INSTALLATION STEPS

- STEP 1. Remove all contents from the received box and check stainless steel tube for any dent. Also verify all brackets and bolts against the parts list.
- STEP 2. Read installation manual and installation drawing completely. Understand all brackets and bolts before installation.
- STEP 3. Remove the body mount bolts from the front, the middle and rear body mounts underneath cab of truck and discard. (Keep the factory bolts and bushings).
- STEP 4. Loosely bolt front, mid and rear mounting brackets to front, mid and rear body mounts using the factory bolts as shown Fig.A. (Make sure factory bushing is put on the same way it is taken off)
- STEP 5. Insert T-bolt(F) into mid holes inside support channel as shown Fig.B. Loosely attach support brace to bolt plate using flange lock nut (G) as shown Fig.A. Attach support brace to mid mounting bracket in center hole using hex bolt (H) flat washer(I) and flange lock nut(G) as shown in Fig.A.
- STEP 7. Mount step bar to mounting bracket using T" bolt(J), lock(K) flat(L) washers as shown. Hand tighten into nutsert on the bottom of the step bar. Adjust position of step bar and tighten all bolts.